

HOOFDSTUK 14

SLANGEN

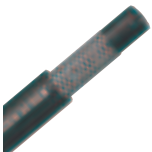

Pagina 720



Pagina 723



Pagina 727



Pagina 729



Pagina 736

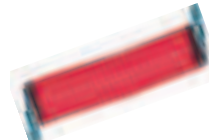

Pagina 739



Pagina 744



Pagina 745



Pagina 747



Pagina 748



Pagina 750



Pagina 754



Pagina 757



Pagina 759



Pagina 761



Pagina 763

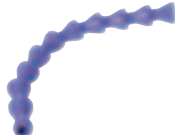

Pagina 766



Pagina 768



Pagina 770



Pagina 771



Pagina 774



Pagina 776



Pagina 777



Pagina 779



Pagina 779



Pagina 780



Pagina 781



Pagina 781



Pagina 785



Pagina 786



Pagina 786



Pagina 789



Pagina 792



Pagina 800



Pagina 804

14 Slangen



Hydrauliek Industriële persluchtslang

Snelkoppelingen Deze PVC persluchtslang is tegen de meeste stoffen bestand die in de industrie en de land- en tuinbouw worden gebruikt. Goed bestand tegen chemische stoffen en tegen olie en benzine. Inwendig versterkt met hoogwaardig polyester. Slijtvast en zeer goed UV- en OZON bestendig.

Afsluiters Blijft ook soepel bij lage temperaturen.

Roestvast staal De in de kolommen hieronder genoemde druk is bij 20°C. Assortimentswijzigingen voorbehouden.

Fittingen 65°C max.

Luchtconditionering Barstdruk = 60

Gereedschap Barstdruk = 60

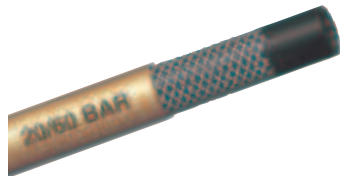

Pneumatiek Soepele PVC persluchtslang

Onderdelen compressoren	SLAN	bar	ID mm	L m	€
	23271308	20	13 x 8	100	113.50
Diversen	23271510	20	15,5 x 10	100	134.60
	23271913	20	19 x 13	100	198.00

Malleabele fittingen & Staal 65°C max.

Ringleidingssystemen

Slangen Barstdruk = 120

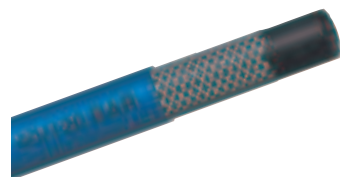

Water, Gas, Sanitair, Verwarming

Hoge druk PVC persluchtslang

	SLAN	bar	ID mm	L m	€
	23241408	40	14 x 8	100	174.70
	23241610	40	16 x 10	100	214.70
	23242113	40	21 x 13	100	330.40

65°C max.

Barstdruk = 60

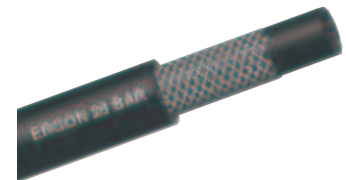

Textielvezel versterkte industriële persluchtslang

SLAN	bar	ID mm	L m	€
23211708	20	17 x 8	50	135.75
23211910	20	19 x 10	50	152.45

65°C max.



20 bar rubber industrie/werkplaats-persluchtslang met textielinlage

SLAN	ID	bar	ID mm	L m	€
AMR100-14	1/4"	20	6.35	100	184.90
AMR100-516	5/16"	20	7.94	100	201.15
AMR100-38	3/8"	20	9.5	100	248.70
AMR100-12	1/2"	20	12.7	100	339.50
AMR100-34	3/4"	20	19.1	100	494.15
AMR100-1	1"	20	25	100	794.70

Slangen



JAYMAC

14

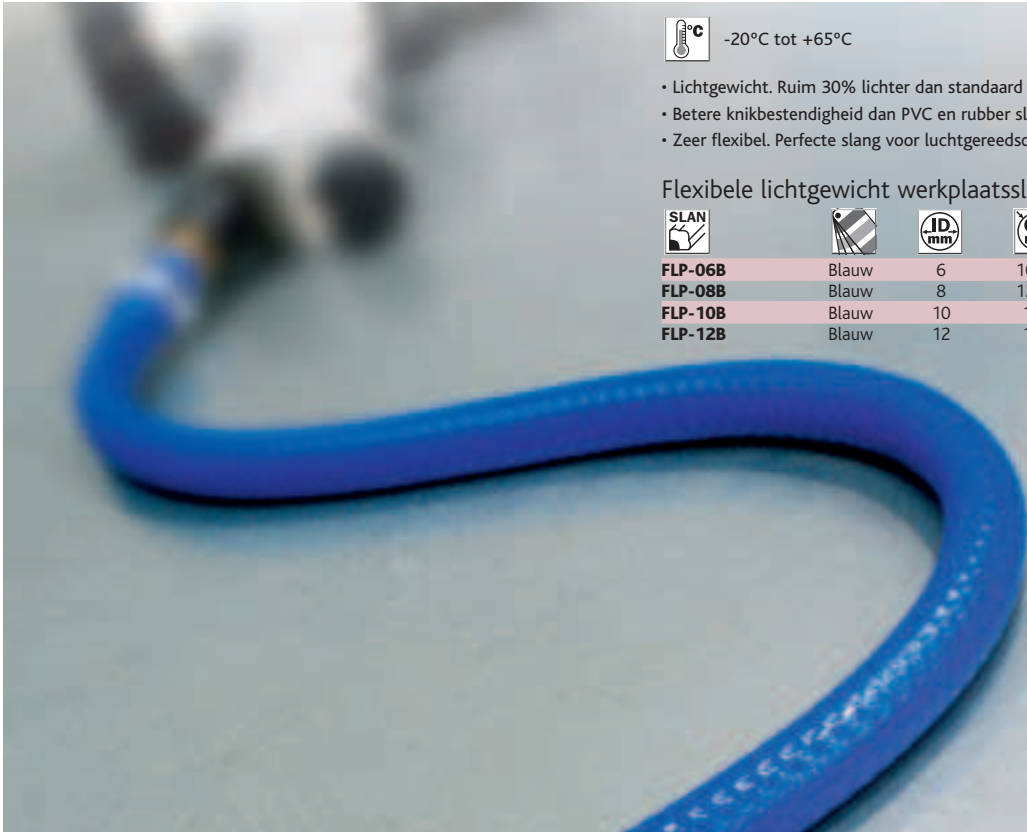

-20°C tot +65°C

- Lichtgewicht. Ruim 30% lichter dan standaard PVC slangen.
- Betere knikbestendigheid dan PVC en rubber slang.
- Zeer flexibel. Perfecte slang voor luchtgereedschap.

Flexibele lichtgewicht werkplaatsslangen - 30 meter rollen

SLAN					€
FLP-06B	Blauw	6	10.5	18	33.20
FLP-08B	Blauw	8	12.5	15	47.35
FLP-10B	Blauw	10	14	13	59.20
FLP-12B	Blauw	12	17	11	71.00

- Hydrauliek
- Snelkoppelingen
- Afsluiters
- Roestvast staal
- Fittingen
- Luchtconditionering
- Gereedschap
- Vacuümtechniek
- Pneumatiek
- Onderdelen compressoren
- Diversen
- Malleabele fittingen & Staal
- Ringleidingssystemen
- Slangen**
- Water, Gas, Sanitair, Verwarming

Slangen



AIRPRO

-20°C tot +60°C

Deze slang oogt en voelt als rubber, zonder de negatieve aspecten die daarmee in verband gebracht worden.

Meer info: technisch datablad nr. 1380



Rubber-Tech werkplaatsslang - 100 meter

SLAN					€
RH06X-100	1/4"	6.3	14	20	95.70
RH08X-100	5/16"	8	17	20	124.10
RH10X-100	3/8"	10	19	20	144.20
RH13X-100	1/2"	12.5	23	20	202.90
RH19X-100	3/4"	19	30	20	286.65
RH25X-100	1"	25	37	20	431.45

14 Slangen



Hydrauliek **PU polyurethaan RAGNO 1812** Snelkoppelingen **FOOD quality**

Groene slijtvaste PU food slang verpakt in handige dozen. Lichtgewicht, sterk, slijtvast en zeer soepel (ook bij lage temperaturen).

Toepassing: Persluchtgereedschap, verfspuiten, pompen, blazen en voedingsmiddelen.

Gecertificeerd: Volgens D.M 21-3-73 en vervolg.

Materiaal: Polyester versterkt met een buitenmantel van TPE.

Fittingen
Luchtconditionering -20°C tot +60°C



Onderdelen compressoren
Diversen Ragno PU polyester versterkte food slang met buitenmantel van TPE voedingsmiddelenkwaliteit

Malleabele fittingen & Staal						
18121006		10	6	20	Groen	100 252.90
18121208		12	8	20	Groen	60 213.20
18121510		15	10	20	Groen	50 235.85
18121913		19	13	20	Groen	30 182.55
18122316		23	16	20	Groen	25 195.05

Water, Gas, Sanitair, Verwarming

Werkplaats slang

Soepel, sterk en knikvrij

Zware, multifunctionele perslucht slang. Zeer soepel, slijtvast. Blijft ook soepel bij lage temperaturen.

Toepassingen: Persluchtgereedschap, verfspuiten, pompen en blazen.

Materiaal: Technopolymeer. Olie-, vet- en UV bestendig.

-20°C tot +60°C



Zeer soepele werkplaats slang, slijtvast en knikvrij, Flex-10

23211206		12	6	15	Zwart	100 178.05
23211508		15	8	15	Zwart	100 220.00
23211510		15	10	14	Zwart	100 225.65

Slangen



Flexy heavy duty gewapende polyurethaan slang

Een uitstekend alternatief voor rubber en plastic slangen.

Zeer geschikt voor industrieel gebruik.

- Ongevoelig voor pulsdrukken.
- Verhard niet doordat geen weekmakers zijn toegevoegd.
- Lichtgewicht.
- Slijtvast en zeer sterk.
- Multifunctioneel voor binnen en buiten.
- Flexibel, ook bij lage temperaturen.



Pu/polyester versterkte industriële heavy duty knikvrije en slijtvaste slang

18251065		10	6,5	15	Blauw	25 38.50
18251208		12	8	15	Blauw	25 40.80
18251410		14,5	10	15	Blauw	25 44.90

Slangen



Layflat slang

10 meter rollen en 100 meter rollen. Multifunctioneel en vlak oprolbaar.

Veiligheidsfactor: 3.1

Toepassing: Bouw, bronbemaling, engineering, industrie, irrigatie, offshore, scheepsvaart.
Niet geschikt voor: aromatics, benzine, chloor, petroleum, spiritus, zuur e.d.

Bestendigheid: zoet en zout water, afvalwater, zwembadwater, sommige oliën en vetten.

! **Attentie:** Iedere temperatuurverhoging boven 20°C heeft een negatief effect op de drukbestendigheid.

De opgegeven druk is gebaseerd op een temperatuur van 20°C.

2 tot 5

-15°C tot +55°C

1,1/4" = 32 mm. t/m 8" = 203 mm.

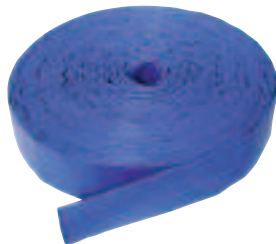

10 meter -Layflat- slang

LFH114-10	1,1/4"	32	5	Blauw	10	15.70	
LFH112-10	1,1/2"	38	5	Blauw	10	16.75	
LFH2-10	2"	50	5	Blauw	10	20.90	
LFH212-10	2,1/2"	63	5	Blauw	10	22.55	
LFH3-10	3"	76	5	Blauw	10	25.40	
LFH4-10	4"	101	3	Blauw	10	47.05	
LFH6-10	6"	152	2,5	Blauw	10	74.20	
LFH8-10	8"	203	2,5	Blauw	10	82.00	

100 meter -Layflat- slang

LFH1-100	1"	25	5	Blauw	100	127.30	
LFH114-100	1,1/4"	32	5	Blauw	100	144.40	
LFH112-100	1,1/2"	38	5	Blauw	100	155.80	
LFH2-100	2"	50	5	Blauw	100	185.25	
LFH212-100	2,1/2"	63	5	Blauw	100	219.45	
LFH3-100	3"	76	5	Blauw	100	250.00	
LFH4-100	4"	102	2,5	Blauw	100	300.00	
LFH6-100	6"	152	2,5	Blauw	100	450.00	
LFH8-100	8"	203	2,5	Blauw	100	750.00	

PVC zuigslang

Ongeveer 15% lichter dan standaard zuigslang.

Toepassingen: Algemene pomp en zuig-toepassingen in de landbouw, industrie en bouw.

Media: Water, slib, drijfmest, chemicaliën en afvalstoffen.

Drukgegevens gelden bij: 20°C / veiligheidsfactor: 3

Temperatuur boven 20°C resulteren in een daling van de werkdruk.

Tech info: MDS1

90% bij 20°C

-10°C tot +60°C



Olijf groen, 10 meter rollen

MDS1-10	1"	3.8	7	125	24.05	
MDS114-10	1.1/4"	4.0	7	160	29.50	
MDS112-10	1.1/2"	4.4	6	190	43.15	
MDS2-10	2"	4.8	5	250	60.05	
MDS212-10	2.1/2"	5.2	4.5	315	80.40	
MDS3-10	3"	5.2	5	300	96.65	
MDS312-10	3.1/2"	5.5	4	375	120.10	
MDS4-10	4"	6.3	4	400	162.20	
MDS6-10	6"	7.5	3	800	310.50	
MDS8-10	8"	8.0	2	900	971.10	

Olijf groen, 30 meter rollen

MSD34-30	3/4"	3.6	7	100	65.00	
MDS1-30	1"	3.8	7	125	72.15	
MDS114-30	1.1/4"	4.0	7	160	88.40	
MDS112-30	1.1/2"	4.4	6	190	129.40	
MDS212-10	2.1/2"	5.2	4.5	315	80.40	
MDS2-30	2"	4.8	5	250	180.10	
MDS212-30	2.1/2"	5.2	4.5	315	240.10	
MDS3-30	3"	5.2	5	300	289.80	
MDS312-30	3.1/2"	5.5	4	375	360.15	
MDS4-30	4"	6.3	4	400	486.40	
MDS6-30	6"	7.5	3	800	931.45	

Grotere maten zijn op aanvraag leverbaar

Hydrauliek
Snelkoppelingen
Afsluiters
Roestvast staal
Fittingen
Luchtconditionering
Gereedschap
Vacuumtechniek
Pneumatiek
Onderdelen compressoren
Diversen
Malleabele fittingen & Staal
Ringleidingssystemen
Slangen
Water, Gas, Sanitair, Verwarming

Voor Cam & Groove koppelingen zie hoofdstuk 2



Voor grote maten slangpilaren zie verderop in dit hoofdstuk

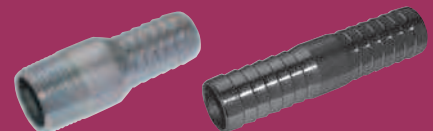

14 Slangen



Hydrauliek

PVC waterslang

Snelkoppelingen

Toepassingen: Algemene pomp en lichte zuig-toepassingen in de landbouw, industrie en bouw.

Afsluiters

Media: Water, lucht, drijfmest, chemicaliën, rioolering en overige afvalstoffen.

Roestvast staal

Drukgegevens gelden bij: 20°C / veiligheidsfactor: 3
Temperatuur boven 20°C resulteren in een daling van de werkdruk.

Fittingen

Tech info: WHD

Luchtconditionering

75% bij 20°C

Gereedschap

-15°C tot +65°C

Vacuümtechniek

Transparant groen, 10 meter rollen

Pneumatiek

WDH34-10		3/4"	2.4	5	110	15.45
WDH1-10		1"	2.4	5	140	20.65
WDH114-10		1.1/4"	2.6	5	180	25.00
WDH112-10		1.1/2"	3.0	5	210	37.10
WDH2-10		2"	3.6	5	270	51.45
WDH212-10		2.1/2"	3.7	5	350	65.00
WDH3-10		3"	4.1	4	500	83.00
WDH4-10		4"	5.6	3	330	135.00

Ringleidingssystemen

Transparant groen, 30 meter rollen

Slangen

WDH34-30		3/4"	2.4	5	110	46.30
WDH1-30		1"	2.4	5	140	61.95
WDH114-30		1.1/4"	2.6	5	180	75.00
WDH112-30		1.1/2"	3.0	5	210	111.15
WDH2-30		2"	3.6	5	270	154.45
WDH212-30		2.1/2"	3.7	5	350	206.35
WDH3-30		3"	4.1	4	500	248.90
WDH4-30		4"	5.6	3	330	392.00

Water, Gas, Sanitair, Verwarming

PVC zuigslang

Helder, versterkt met blauwe staadraadspiraal
Multifunctioneel. Rollen van 10 en 30 meter.

US FDA approved



Veiligheidsfactor: 3.1

Toepassing: Bouw, bronbemaling, chemie, engineering, industrie, laboratoria, land- en tuinbouw, offshore, scheepsbouw & scheepvaart.

Bestendigheid: Afvalwater, chemicaliën, granulaat, opgeloste zuren en zouten, zwembadwater, zoet en zout water en de meeste afvalstoffen opgelost in water. (multi bestendig)

Attentie: ledere temperatuurverhoging boven 20°C heeft effect op de druk en vacuumbestendigheid.

Vacuüm: 711 mm Hg. = 94% bij 20°C.

2 tot 5

-15°C tot +55°C

3/4" = 19 mm
1/m. 3" = 76 mm



10 meter, heldere PVC zuigslang

FX075-10		3/4"	26	19	Helder	10	24.05
FX100-10		1"	33	25,4	Helder	10	28.25
FX125-10		1,1/4"	41	32	Helder	10	35.55
FX150-10		1,1/2"	49	38	Helder	10	46.00
FX200-10		2"	64,8	51	Helder	10	65.85
FX250-10		2,1/2"	77,5	63,5	Helder	10	110.20
FX300-10		3"	92	76	Helder	10	114.95

30 meter, heldere PVC zuigslang

FX050-30		1/2"	19	13	Helder	30	33.45
FX075-30		3/4"	26	19	Helder	30	61.70
FX100-30		1"	33	25,4	Helder	30	72.15
FX150-30		1,1/2"	49	38	Helder	30	120.65
FX200-30		2"	64,8	51	Helder	30	181.45
FX300-30		3"	92	76	Helder	30	345.00

Slangen



PE polyethyleen

Zuurbestendig en zeer soepel. Niet geschikt voor olie, vet en benzine.

Voedingskwaliteit LD PE.

Gecalibreerd volgens DIN 8072 TOL.



-40°C tot +60°C



LD-PE - Gecalibreerde polyethyleen slang

PE	OD mm	ID mm	bar		mm	€
15200402	4	2	20	Naturel	100	29.25
15210402	4	2	20	Zwart	100	31.00
15220402	4	2	20	Groen	100	31.00
15230402	4	2	20	Rood	100	31.00
15240402	4	2	20	Blauw	100	31.00
15250402	4	2	20	Geel	100	31.00
15200503	5	3	15	Naturel	100	35.55
15210503	5	3	15	Zwart	100	37.30
15220503	5	3	15	Groen	100	37.30
15230503	5	3	15	Rood	100	37.30
15240503	5	3	15	Blauw	100	37.30
15250503	5	3	15	Geel	100	37.30
15200604	6	4	12	Naturel	100	39.05
15210604	6	4	12	Zwart	100	41.15
15220604	6	4	12	Groen	100	41.15
15230604	6	4	12	Rood	100	41.15
15240604	6	4	12	Blauw	100	41.15
15250604	6	4	12	Geel	100	41.15
15200806	8	6	9	Naturel	100	53.50
15210806	8	6	9	Zwart	100	56.10
15220806	8	6	9	Groen	100	56.10
15230806	8	6	9	Rood	100	56.10
15240806	8	6	9	Blauw	100	56.10
15250806	8	6	9	Geel	100	56.10
15201007	10	7	10	Naturel	100	104.10
15211007	10	7	10	Zwart	100	109.05
15221007	10	7	10	Groen	100	109.05
15231007	10	7	10	Rood	100	109.05
15241007	10	7	10	Blauw	100	109.05
15251007	10	7	10	Geel	100	109.05
15201008	10	8	6	Naturel	100	69.80
15211008	10	8	6	Zwart	100	74.65
15221008	10	8	6	Groen	100	74.65
15231008	10	8	6	Rood	100	74.65
15241008	10	8	6	Blauw	100	74.65
15251008	10	8	6	Geel	100	74.65
15201209	12	9	6	Naturel	100	121.30
15211209	12	9	6	Zwart	100	133.40
15241209	12	9	6	Blauw	100	133.40
15241512	15	12	6	Blauw	100	165.40
15201512	15	12	6	Naturel	100	157.65
15201612	16	12	6	Naturel	100	223.80

Haspels met lengtes tot 500 meter zijn op aanvraag leverbaar.

Hydrauliek
Snelkoppelingen
Afsluiters
Roestvast staal
Fittingen
Luchtconditionering
Gereedschap
Vacuumtechniek
Pneumatiek
Onderdelen compressoren
Diversen
Malleabele fittingen & Staal
Ringleidingssystemen
Slangen
Water, Gas, Sanitair, Verwarming

14 Slangen



Hydrauliek			
Snelkoppelingen		PN16	PN24
Afsluiters	20°C	16	24
	30°C	10	16
	40°C	6,5	9,5
Roestvast staal	45°C	5	8



HD PE - Gecalibreerde polyethyleen slang PN16 - zeer hoge moleculaire dichtheid

Pneumatiek							
Onderdelen compressoren	14020046101	6	4,4	16	Wit	100	44.00
	14020048101	8	6	16	Wit	100	50.70
	14020046102	6	4,4	16	Zwart	100	44.00
Diversen	14020048102	8	6	16	Zwart	100	50.70
	14020046108	6	4,4	16	Blauw	100	44.00
Malleabele fittingen & Staal	14020048108	8	6	16	Blauw	100	50.70



HD PE - Gecalibreerde polyethyleen slang PN24 - zeer hoge moleculaire dichtheid

Water, Gas, Sanitair, Verwarming							
	14010046102	6	4,4	24	Zwart	100	50.70
	14010048102	8	6	24	Zwart	100	60.90

-20°C tot +70°C



Materiaal: Nylon 6
Andere kleuren en lengtes zijn op aanvraag leverbaar.

• UV bestendig • Sillicone vrij • slijtvast

Vervaardigd uit kwaliteits grondstoffen
Zeer geschikt voor gebruik in pneumatische systemen
(Bij uitstek geschikt voor gebruik met push-in fittingen)

PA-Nylon 6 - Gecalibreerde polyamide slang - 100 meter rollen

NTM04025-100	4	2,5	Naturel	27	21.60	
NTM05030-100	5	3	Naturel	27	29.35	
NTM06040-100	6	4	Naturel	24	41.40	
NTM0604N-100	6	4	Zwart	24	41.40	
NTM06040B-100	6	4	Blauw	24	41.40	
NTM06040G-100	6	4	Groen	24	41.40	
NTM06040R-100	6	4	Rood	24	41.40	
NTM06040Y-100	6	4	Geel	24	43.70	
NTM08060-100	8	6	Naturel	24	60.40	
NTM08060N-100	8	6	Zwart	24	60.40	
NTM08060B-100	8	6	Blauw	24	60.40	
NTM08060G-100	8	6	Groen	24	63.75	
NTM08060R-100	8	6	Rood	24	63.75	
NTM08060Y-100	8	6	Geel	24	63.75	
NTM10080-100	10	8	Naturel	15	74.85	
NTM10080N-100	10	8	Zwart	15	74.85	
NTM10080B-100	10	8	Blauw	15	74.85	
NTM10080G-100	10	8	Groen	15	74.85	
NTM10080R-100	10	8	Rood	15	74.85	
NTM10080Y-100	10	8	Geel	15	74.85	

Slangen



PA polyamide (Nylon 12)

Olie- en benzinebestendig. Niet zuurbestendig. Gecalibreerd volgens CETOP.

Ook leverbaar op haspels. Andere maten en kleuren zijn op aanvraag leverbaar.



-40°C tot +70°C



PA-Nylon 12 - Gecalibreerde polyamide slang - DIN 73378

PAEF	OD mm	ID mm	bar		L m	€
16200402	4	2	45	Naturel	100	63.10
16210402	4	2	45	Zwart	100	63.20
16220402	4	2	45	Groen	100	66.20
16230402	4	2	45	Rood	100	63.20
16240402	4	2	45	Blauw	100	63.20
16250402	4	2	45	Geel	100	66.20
16100402	4	2	45	Naturel	25	16.40
16110402	4	2	45	Zwart	25	17.10
16120402	4	2	45	Groen	25	17.10
16130402	4	2	45	Rood	25	17.10
16140402	4	2	45	Blauw	25	17.10
16150402	4	2	45	Geel	25	17.10
16200427	4	2,7	30	Naturel	100	44.10
16210427	4	2,7	30	Zwart	100	46.00
16220427	4	2,7	30	Groen	100	46.00
16230427	4	2,7	30	Rood	100	46.00
16240427	4	2,7	30	Blauw	100	46.00
16250427	4	2,7	30	Geel	100	46.00
16100427	4	2,7	30	Naturel	25	11.60
16110427	4	2,7	30	Zwart	25	12.00
16120427	4	2,7	30	Groen	25	12.00
16130427	4	2,7	30	Rood	25	12.00
16140427	4	2,7	30	Blauw	25	12.00
16150427	4	2,7	30	Geel	25	12.00
16200503	5	3	35	Naturel	100	94.95
16210503	5	3	35	Zwart	100	99.60
16220503	5	3	35	Groen	100	99.60
16230503	5	3	35	Rood	100	99.60
16240503	5	3	35	Blauw	100	99.60
16250503	5	3	35	Geel	100	99.60
16100503	5	3	35	Naturel	25	23.70
16110503	5	3	35	Zwart	25	24.95
16120503	5	3	35	Groen	25	24.95
16130503	5	3	35	Rood	25	24.95
16140503	5	3	35	Blauw	25	24.95
16150503	5	3	35	Geel	25	24.95
16200604	6	4	27	Naturel	100	80.50
16210604	6	4	27	Zwart	100	84.45
16220604	6	4	27	Groen	100	84.45
16230604	6	4	27	Rood	100	84.45
16240604	6	4	27	Blauw	100	84.45
16250604	6	4	27	Geel	100	84.45
16100604	6	4	27	Naturel	25	20.20
16110604	6	4	27	Zwart	25	21.85
16120604	6	4	27	Groen	25	21.85
16130604	6	4	27	Rood	25	21.85
16140604	6	4	27	Blauw	25	21.85
16150604	6	4	27	Geel	25	21.85
16200806	8	6	19	Naturel	100	113.55
16210806	8	6	19	Zwart	100	119.05
16220806	8	6	19	Groen	100	119.05
16230806	8	6	19	Rood	100	119.05
16240806	8	6	19	Blauw	100	119.05
16250806	8	6	19	Geel	100	119.05
16100806	8	6	19	Naturel	25	28.25
16110806	8	6	19	Zwart	25	30.85
16120806	8	6	19	Groen	25	30.85
16130806	8	6	19	Rood	25	30.85
16140806	8	6	19	Blauw	25	30.85
16150806	8	6	19	Geel	25	30.85

Haspels met lengtes tot 500 meter zijn op aanvraag leverbaar.

Hydrauliek
Snelkoppelingen
Afsluiters
Roestvast staal
Fittingen
Luchtconditionering
Gereedschap
Vacuümtechniek
Pneumatiek
Onderdelen compressoren
Diversen
Malleabele fittingen & Staal
Ringleidingssystemen
Slangen
Water, Gas, Sanitair, Verwarming

14 Slangen



Hydrauliek PA polyamide (Nylon 12) PA-Nylon 12 - Gecalibreerde polyamide slang - DIN 73378 (vervolg)

	PAEF	OD mm	ID mm	bar		L m	€
Afsluiters	16201008	10	8	15	Naturel	100	165.40
	16211008	10	8	15	Zwart	100	175.30
Roestvast staal	16221008	10	8	15	Groen	100	175.30
	16231008	10	8	15	Rood	100	175.30
Fittingen	16241008	10	8	15	Blauw	100	175.30
	16251008	10	8	15	Geel	100	175.30
	16101008	10	8	15	Naturel	25	42.45
Luchtconditionering	16111008	10	8	15	Zwart	25	45.00
	16121008	10	8	15	Groen	25	45.00
	16131008	10	8	15	Rood	25	45.00
Gereedschap	16141008	10	8	15	Blauw	25	45.00
	16151008	10	8	15	Geel	25	45.00
Vacuumtechniek	16201075	10	7,5	20	Naturel	100	203.95
	16211075	10	7,5	20	Zwart	100	211.70
Pneumatiek	16221075	10	7,5	20	Groen	100	211.70
	16231075	10	7,5	20	Rood	100	211.70
	16241075	10	7,5	20	Blauw	100	211.70
Onderdelen compressoren	16251075	10	7,5	20	Geel	100	211.70
	16101075	10	7,5	20	Naturel	25	50.70
Diversen	16111075	10	7,5	20	Zwart	25	54.00
	16121075	10	7,5	20	Groen	25	54.00
	16131075	10	7,5	20	Rood	25	54.00
Malleabele fittingen & Staal	16141075	10	7,5	20	Blauw	25	54.00
	16151075	10	7,5	20	Geel	25	54.00
Ringleidingssystemen	16201210	12	10	12	Naturel	100	210.60
	16211210	12	10	12	Zwart	100	221.60
	16221210	12	10	12	Groen	100	221.60
Slangen	16231210	12	10	12	Rood	100	221.60
	16241210	12	10	12	Blauw	100	221.60
Water, Gas, Sanitair, Verwarming	16251210	12	10	12	Geel	100	221.60
	16101210	12	10	12	Naturel	25	55.40
	16111210	12	10	12	Zwart	25	58.30
	16121210	12	10	12	Groen	25	58.30
	16131210	12	10	12	Rood	25	58.30
	16141210	12	10	12	Blauw	25	58.30
	16151210	12	10	12	Geel	25	58.30
	16201209	12	9	19	Naturel	100	292.15
	16211209	12	9	19	Zwart	100	307.60
	16221209	12	9	19	Groen	100	307.60
	16231209	12	9	19	Rood	100	307.60
	16241209	12	9	19	Blauw	100	307.60
	16251209	12	9	19	Geel	100	307.60
	16101209	12	9	19	Naturel	25	74.65
	16111209	12	9	19	Zwart	25	79.75
	16121209	12	9	19	Groen	25	79.75
	16131209	12	9	19	Rood	25	79.75
	16141209	12	9	19	Blauw	25	79.75
	16151209	12	9	19	Geel	25	79.75
	16201411	14	11	16	Naturel	100	363.80
	16211411	14	11	16	Zwart	100	379.25
	16221411	14	11	16	Groen	100	379.25
	16231411	14	11	16	Rood	100	379.25
	16241411	14	11	16	Blauw	100	379.25
	16251411	14	11	16	Geel	100	379.25
	16101411	14	11	16	Naturel	25	93.85
	16111411	14	11	16	Zwart	25	99.00
	16121411	14	11	16	Groen	25	99.00
	16131411	14	11	16	Rood	25	99.00
	16141411	14	11	16	Blauw	25	99.00
	16151411	14	11	16	Geel	25	99.00

	PAEF	OD mm	ID mm	bar		L m	€
	16201512	15	12	12	Naturel	100	384.75
	16211512	15	12	12	Zwart	100	404.60
	16221512	15	12	12	Groen	100	404.60
	16231512	15	12	12	Rood	100	404.60
	16241512	15	12	12	Blauw	100	404.60
	16251512	15	12	12	Geel	100	404.60
	16101512	15	12	12	Naturel	25	101.60
	16111512	15	12	12	Zwart	25	106.70
	16121512	15	12	12	Groen	25	106.70
	16131512	15	12	12	Rood	25	106.70
	16141512	15	12	12	Blauw	25	106.70
	16151512	15	12	12	Geel	25	106.70
	16211613	16	13	14	Zwart	100	503.85
	16201814	18	14	16	Naturel	100	606.40
	16211814	18	14	16	Zwart	100	618.50
	16221814	18	14	16	Groen	100	618.50
	16231814	18	14	16	Rood	100	618.50
	16241814	18	14	16	Blauw	100	618.50
	16251814	18	14	16	Geel	100	618.50
	16101814	18	14	16	Naturel	25	160.95
	16111814	18	14	16	Zwart	25	169.80
	16121814	18	14	16	Groen	25	169.80
	16131814	18	14	16	Rood	25	169.80
	16141814	18	14	16	Blauw	25	169.80
	16151814	18	14	16	Geel	25	169.80

Andere maten, kleuren en haspels met lengtes tot 500 meter zijn op aanvraag leverbaar.

PA hard voor hoge druk

Olie- en benzinebestendig. Niet zuurbestendig.
Toepassingen: Vet- baansmering e.d.

-40°C tot +70°C



PA-Nylon Hard - Gecalibreerde hogedruk polyamide slang

	PAHA	OD mm	ID mm	bar		L m	€
	19210402	4	2	75	Zwart	100	91.95
	19200603	6	3	70	Wit	100	159.50
	19210603	6	3	70	Zwart	100	152.25
	19200805	8	5	52	Wit	100	200.55
	19210805	8	5	52	Zwart	100	210.10

Slangen



PU polyurethaan

Uitstekende kwaliteit, tegen een zeer scherpe prijs. Olie- en benzinebestendig. Niet zuurbestendig. Flexibel en knikherstellend.

Veiligheidsfactor: 3.



7 tot 13



-20°C tot +55°C



2 t/m 8 mm

! **Attentie:** Iedere temperatuurverhoging boven 20°C heeft een negatief effect op de drukbestendigheid. De in de tabel opgeven druk is gebaseerd op een temperatuur van 20°C.



PU - Knikvrije gec calibreerde polyurethaan slang - 25 meter rollen

PU	OD mm	ID mm	bar	Knik	L m	€
PU03/020B	3	2	10	Blauw	25	8.55
PU06/040N	6	4	11	Zwart	25	14.85
PU06/040B	6	4	11	Blauw	25	14.85
PU06/040R	6	4	11	Rood	25	14.85
PU06/040Y	6	4	11	Geel	25	14.85
PU06/040G	6	4	11	Groen	25	14.85
PU06/040	6	4	11	Transparant	25	14.85
PU08/060N	8	6	8	Zwart	25	22.40
PU08/060B	8	6	8	Blauw	25	22.40
PU08/060R	8	6	8	Rood	25	22.40
PU08/060Y	8	6	8	Geel	25	22.40
PU08/060G	8	6	8	Groen	25	22.40
PU08/060	8	6	8	Transparant	25	22.40
PU08/050N	8	5,5	11	Zwart	25	23.85
PU08/050B	8	5,5	11	Blauw	25	23.85
PU08/050R	8	5,5	11	Rood	25	23.85
PU08/050Y	8	5,5	11	Geel	25	23.85
PU08/050	8	5,5	11	Transparant	25	23.85
PU10/065N	10	6,5	10	Zwart	25	45.35
PU10/065B	10	6,5	10	Blauw	25	45.35
PU10/065R	10	6,5	10	Rood	25	45.35
PU10/065Y	10	6,5	10	Geel	25	45.35
PU10/065G	10	6,5	10	Groen	25	45.35
PU10/065	10	6,5	10	Transparant	25	45.35
PU12/080N	12	8	9	Zwart	25	61.80
PU12/080B	12	8	9	Blauw	25	61.80
PU12/080R	12	8	9	Rood	25	61.80
PU12/080Y	12	8	9	Geel	25	61.80
PU12/080G	12	8	9	Groen	25	61.80
PU12/080	12	8	9	Transparant	25	61.80

PU - Knikvrije gec calibreerde polyurethaan slang - 100 meter rollen

PU	OD mm	ID mm	bar	Knik	L m	€
PU06/040N-100	6	4	11	Zwart	100	59.40
PU06/040B-100	6	4	11	Blauw	100	59.40
PU06/040R-100	6	4	11	Rood	100	59.40
PU06/040Y-100	6	4	11	Geel	100	59.40
PU06/040G-100	6	4	11	Groen	100	59.40
PU06/040-100	6	4	11	Transparant	100	59.40
PU08/055N-100	8	5,5	11	Zwart	100	94.50
PU08/055B-100	8	5,5	11	Blauw	100	94.50
PU08/055R-100	8	5,5	11	Rood	100	94.50
PU08/055Y-100	8	5,5	11	Geel	100	94.50
PU08/055G-100	8	5,5	11	Groen	100	94.50
PU08/055-100	8	5,5	11	Transparant	100	94.50
PU08/060N-100	8	6	8	Zwart	100	88.80
PU08/060B-100	8	6	8	Blauw	100	88.80
PU08/060R-100	8	6	8	Rood	100	88.80
PU08/060Y-100	8	6	8	Geel	100	88.80
PU08/060G-100	8	6	8	Groen	100	88.80
PU08/060-100	8	6	8	Transparant	100	88.80
PU10/065N-100	10	6,5	10	Zwart	100	180.00
PU10/065B-100	10	6,5	10	Blauw	100	180.00
PU10/065R-100	10	6,5	10	Rood	100	180.00
PU10/065Y-100	10	6,5	10	Geel	100	180.00
PU10/065G-100	10	6,5	10	Groen	100	180.00
PU10/065-100	10	6,5	10	Transparant	100	180.00
PU12/080N-100	12	8	9	Zwart	100	244.80
PU12/080B-100	12	8	9	Blauw	100	244.80
PU12/080R-100	12	8	9	Rood	100	244.80
PU12/080Y-100	12	8	9	Geel	100	244.80
PU12/080G-100	12	8	9	Groen	100	244.80
PU12/080-100	12	8	9	Transparant	100	244.80

Hydrauliek
Snelkoppelingen
Afsluiters
Roestvast staal
Fittingen
Luchtconditionering
Gereedschap
Vacuümtechniek
Pneumatiek
Onderdelen compressoren
Diversen
Malleabele fittingen & Staal
Ringleidingssystemen
Slangen
Water, Gas, Sanitair, Verwarming

14 Slangen



Hydrauliek **PU polyurethaan**

Snelkoppelingen Uiterst flexibel en knikherstellend. Olie- en benzinebestendig. Niet zuurbestendig. Veiligheidsfactor: 3.

Afsluiters  **Attentie: ledere temperatuurverhoging boven 20°C heeft een negatief effect op de drukbestendigheid. De in de tabel opgeven druk is gebaseerd op een temperatuur van 20°C.**

Roestvast staal  10 tot 16

Fittingen  -20°C tot +55°C

Luchtconditionering  -20°C tot +55°C

Gereedschap  4 t/m 7 mm

Vacuümtechniek

Pneumatiek

Onderdelen compressoren

Diversen

Malleabele fittingen & Staal

Ringleidingssystemen

Slangen

Water, Gas, Sanitair, Verwarming



PU - Nikkvrije gecalibreerde polyurethaan slang

PU	OD mm	ID mm	bar		L m	€
18200427	4	2,7	12	Naturel	100	44.50
18210427	4	2,7	12	Zwart	100	44.50
18220427	4	2,7	12	Groen	100	44.50
18230427	4	2,7	12	Rood	100	44.50
18240427	4	2,7	12	Blauw	100	44.50
18250427	4	2,7	12	Geel	100	44.50
18200604	6	4	16	Naturel	100	81.25
18210604	6	4	16	Zwart	100	81.25
18220604	6	4	16	Groen	100	81.25
18230604	6	4	16	Rood	100	81.25
18240604	6	4	16	Blauw	100	81.25
18250604	6	4	16	Geel	100	81.25
18200806	8	6	10	Naturel	100	117.60
18210806	8	6	10	Zwart	100	117.60
18220806	8	6	10	Groen	100	117.60
18230806	8	6	10	Rood	100	117.60
18240806	8	6	10	Blauw	100	117.60
18250806	8	6	10	Geel	100	117.60
18200855	8	5,5	13	Naturel	100	144.90
18210855	8	5,5	13	Zwart	100	144.90
18220855	8	5,5	13	Groen	100	144.90
18230855	8	5,5	13	Rood	100	144.90
18240855	8	5,5	13	Blauw	100	144.90
18250855	8	5,5	13	Geel	100	144.90
18201007	10	7	10	Naturel	100	213.15
18211007	10	7	10	Zwart	100	213.15
18221007	10	7	10	Groen	100	213.15
18231007	10	7	10	Rood	100	213.15
18241007	10	7	10	Blauw	100	213.15
18251007	10	7	10	Geel	100	213.15

Haspels met lengtes tot 500 meter zijn op aanvraag leverbaar.

Slangen

Hyflex/Hytrek vonkbestendige slang

- Lasvonk bestendig (SSA). -Olie- en benzinebestendig. -Antistatisch.
- Tot 70° C redelijk bestendig tegen zuren, bazen, aminen en glycol.

-40°C tot +80°C
kortstondig tot 120°C



Gecalibreerde antistatische, vonkbestendige Hytrek slang

SLWP	OD mm	ID mm	bar	SL	L m	€
21260604	6	4	18	Grijs	100	164.65
21260806	8	6	10	Grijs	100	237.55
21261075	10	7,5	10	Grijs	100	383.40

PPC poly-propyleen-copolymeer

Voedingsmiddelenkwaliteit. Zeer geschikt voor CV, vloerverwarming en drinkwatersystemen. Zeer goed en snel te installeren met behulp van push-in fittingen serie 1400. Gecalibreerd volgens DIN.

Licht zuurbestendig. Niet olie- en benzinebestendig. Ook leverbaar op haspels.

-30°C tot +90°C
kortstondig tot 120°C



PPC voedings kwaliteit gecalibreerde polypropyleen-copolymeer slang

SLAN	OD mm	ID mm	bar	SL	L m	€
22200604	6	4	24	Wit	100	88.80
22210604	6	4	24	Zwart	100	93.60
22200806	8	6	17	Wit	100	115.85
22210806	8	6	17	Zwart	100	123.50
22011511	15	11	15	Zwart	50	124.65
22001511	15	11	15	Wit	50	124.65
22011814	18	14,5	12	Zwart	50	149.35
22012217	22	17	12	Zwart	50	207.00
22002217	22	17	12	Wit	50	219.90

PTFE (Teflon) DuPont

Zeer goede temperatuur- en chemische bestendigheid. Zuurbestendig.

De werkdruk is zeer afhankelijk van de temperatuur.

Gecalibreerd volgens CETOP.

-60°C tot +200°C



Andere maten of uitvoeringen zijn op aanvraag leverbaar.

Als gevolg van milieu vriendelijke productie methoden kunnen de rollengtes van de bovenstaande PTFE slangen afwijken of worden onderbroken. Onderbrekingen worden met een gekleurde plakker aangegeven!

Gecalibreerde PTFE slang - Zuur-, loog-, olie- en benzinebestendig

SLAN	OD mm	ID mm	bar	SL	L m	€
24200604	6	4	16	Naturel	CA. 100	436.65
24100604	6	4	16	Naturel	CA. 25	111.00
24200806	8	6	11	Naturel	CA. 100	630.50
24100806	8	6	11	Naturel	CA. 25	157.70
24200810	10	8	10	Naturel	CA. 100	680.40
24200912	12	9	10	Naturel	CA. 100	1354.00
24201114	14	11	10	Naturel	CA. 100	1528.60
24201215	15	12	10	Naturel	CA. 100	1746.35

Vinnylan persluchtslang

Deze vinnylan luchtslang is een bijzondere kwaliteitsslant die zich onderscheidt door de volgende kenmerken:

- Zeer fijn synthetisch geweven beschermmantel.
- Zeer flexibel en lichtgewicht.
- Vergaand chemisch bestendig tegen: olie, benzine, verdunde zuren, logen, enz
- Dunwandig.
- Slijtvast.

Op aanvraag leverbaar in andere kleuren. (minimaal 1000 meter per maat voor speciale kleur)

-30°C tot +80°C 25



Vinnylan persluchtslang met vinyl beschermantel - Zuur-, loog-, olie- en benzinebestendig

SLWP	OD mm	ID mm	bar	SL	L m	€
80706204	6,2	4	40	Blauw	50	151.85
80708206	8,2	6	40	Blauw	50	159.80
80701008	10,2	8	35	Blauw	50	180.20
80701109	11,6	9	30	Blauw	50	198.30
80701210	12,5	10	28	Blauw	50	277.60
80701713	17,6	13	28	Blauw	50	330.90

Hydrauliek
Snelkoppelingen
Afsluiters
Roestvast staal
Fittingen
Luchtconditionering
Gereedschap
Vacuümtechniek
Pneumatiek
Onderdelen compressoren
Diversen
Malleabele fittingen & Staal
Ringleidingssystemen
Slangen
Water, Gas, Sanitair, Verwarming

14 Slangen



Hydrauliek

Vinnylan voedingsmiddelenkwaliteit

Snelkoppelingen

- Voor drinkwater, voedingsstoffen, perslucht en ademlucht.
- Laat geen geur of smaak na. Geschikt voor opsteekkoppelingen.

Afsluiters

- Deze slang is zeer slijtvast, lichtgewicht en bestand tegen waterslag. Tevens zeer goed bestand tegen UV licht.

Roestvast staal

- Door de fijne kruisweving treedt bij 8 BAR ca. 2% lengtekrimp op.



Fittingen

Luchtconditionering

Gereedschap

Vinnylan voedingslang met vinyl beschermantel - Zuur-, loog-, olie- en bezinebestendig

Vacuümtechniek



Pneumatiek

81708206 8,2 6 40 Zwart 50 173.35

Onderdelen compressoren

Diversen

Malleabele fittingen & Staal

Ringleidingssystemen

Slangen

Water, Gas, Sanitair, Verwarming

Siliconenslang

Voor drinkwater, koffiemachines, voedingsstoffen etc.



-60°C tot +200°C

Gecalibreerd volgens UNI 3302 CLE2

Hardheid = 60 ° shore

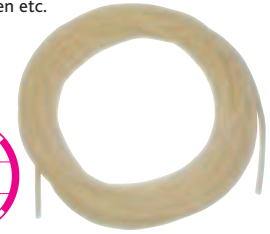

Siliconenslang - industrie kwaliteit - max. 4 bar - rollengtes verschillen



	OD mm	ID mm	Transparant	L m	€
SIL64	6	4	Transparant	50	44.40
SIL74	7	4	Transparant	50	70.50
SIL75	7	5	Transparant	50	53.00
SIL85	8	5	Transparant	50	82.30
SIL86	8	6	Transparant	50	58.85
SIL96	9	6	Transparant	50	94.05
SIL106	10	6	Transparant	50	137.80
SIL118	11	8	Transparant	50	121.20
SIL128	12	8	Transparant	50	168.70

Slangen



- Hydrauliek
- Snelkoppelingen
- Afsluiters
- Roestvast staal
- Fittingen
- Luchtconditionering
- Gereedschap
- Vacuümtechniek
- Pneumatiek
- Onderdelen compressoren
- Diversen
- Malleabele fittingen & Staal
- Ringleidingssystemen
- Slangen**
- Water, Gas, Sanitair, Verwarming

Vloerverwarmings slang

PE-X en COBRA-PE-X kunststof buis voor sanitair, vloerverwarming en centrale verwarming kan zowel zonder als met mantel ingemetseld worden. Let er op dat de inmetingsdiepte ongeveer 2,5 tot 3 x de buisdiameter is. Dit om latere scheurvorming in de deklaag te voorkomen.

PE-X & COBRA-PE-X buis is van moleculair veranderde lagedruk polyethyleen. De buis wordt zeer vakkundig vervaardigd en met uiterste precisie gecontroleerd. Deze kwaliteit is gecertificeerd met ISO-9002-EN 29002-Sert.nr. ER-114/2/95. NI-9338-UNE 53-381 - DIN 16892. De kunststof buis is bestlist niet toxisch (gifvrij) en mag daarom ook voor drinkwater gebruikt worden, certificaat nr. 99/96.



16 bar bij 20°C / 10 bar bij 95°C



PE-X (cross linked polyethyleen) kunststof buis gecertificeerd voor cv, vloerverwarming & sanitair



PE	OD mm	ID mm		L m	€
PEX-N12	12	8	Naturel	100	142.95
PEX-N15	15	10	Naturel	100	128.90
PEX-N16	16	12	Naturel	100	131.40
PEX-N22	22	16	Naturel	100	238.15
PEX-N28	28	22	Naturel	50	168.30
PEX-Z12	12	8	Zwart	100	145.45
PEX-Z15	15	10	Zwart	100	131.40
PEX-Z16	16	12	Zwart	100	119.85
PEX-Z22	22	16	Zwart	100	247.05
PEX-Z28	28	22	Zwart	50	213.85



Cobra-PEX-N (cross linked anti-oxygen barrier pipe) zuurstofdichte pe buis - gecertificeerd voor cv, vloerverwarming & sanitair

PE	OD mm	ID mm		L m	€
CPEX-N-15	15	11	Naturel	100	233.60
CPEX-N-16	16	12	Naturel	120	251.10

Op de plek van toepassing (de bouwplaats) moet de PE-X buis uit het zonlicht, koel en schoon in een afsluitbare ruimte op een gladde ondergrond opgeslagen worden. Direct zonlicht kan de structuur veranderen Een scherpe betonvloer kan het oppervlak beschadigen. Het productie- en controleproces van COBRA-PE-X buis (anti oxygen barrier pipe) garandeert een kunststof buis die bestlist (binnen het moleculaire vereisbare niveau) geen zuurstof en andere gassen doorlaat. Als PE-X en COBRA-PE-X met onze gecertificeerde verdeelblokken en fittingen aangesloten wordt, is de montage snel en de installatie gegarandeerd veilig en lekdicht.

Cobra-PEX-B (cross linked polyethyleen) blauw ommantelde kunststof buis gecertificeerd voor cv, vloerverwarming & sanitair

PE	OD mm	ID mm		L m	€
CPEXB-12	12	8	Blauw	50	100.35
CPEXB-15	15	10	Blauw	50	129.50
CPEXB-16	16	12	Blauw	50	122.50



Cobra-PEX-R (cross linked polyethyleen) rood ommantelde kunststof buis, gecertificeerd voor cv, vloerverwarming & sanitair

PE	OD mm	ID mm		L m	€
CPEXR-12	12	8	Rood	50	102.40
CPEXR-15	15	10	Rood	50	129.50
CPEXR-16	16	12	Rood	50	122.50



Bij het aansluiten van PE-X en COBRA-PE-X altijd VSH steunhulzen toepassen.

Gevlochten PVC Slang

Gemaakt van hoogwaardig, transparante, niet gerecycled PVC materiaal.

Zeer geschikt voor vele industriële toepassingen. Versterkt met flexibel polyester vezel. Bestand tegen hoge druk en zeer flexibel.

Deze slang is bestand tegen een breed scala aan chemicaliën.

Voor meer informatie over de bestendigheid; zie achter in dit hoofdstuk.

Toepassingen:

- doorvoer diverse vloeibare stoffen en poeders
- toe- en afvoer van water, perslucht, gassen en olie.

Kenmerken van het materiaal:

- slijtvast
- flexibel
- zuurbestendig
- uv en ultravioletbestendig
- siliconen- en cadmiumvrij
- transparant
- gefabriceerd volgens de ISO5774 en BS6066 norm
- voldoet aan de eisen van de voedingsmiddelenindustrie
- duurzaam, lichtgewicht en makkelijk hanteerbaar.

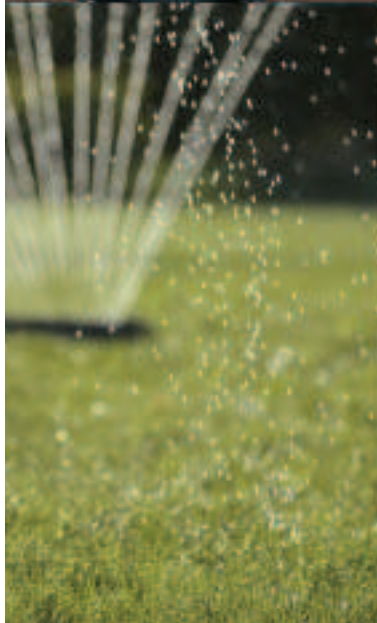

PVC Slangen



Multifunctionele PVC slang - Heavy Duty

Extreme flexibiliteit. Zeer hoogwaardige kwaliteit; ook food quality (BS6066)

Veiligheidsfactor: 3.

Materiaal: PVC & polyester inlaag.



Attentie: Iedere temperatuurverhoging boven 20°C heeft een negatief effect op de drukbestendigheid.

De hieronder aangegeven druk is gebaseerd op een temperatuur van 20°C. 10, 20, 30, 50 en 100 meter rollen.



10 tot 16 bar



-20°C tot +65°C



HD-PVC met textielinlage - helder of gekleurd

PVC	OD mm	ID mm	L m	bar	Color	Price
HDPVC14-100	11.5	6.5	100	16	Transparant	54.40
HDPVC14N-100	11.5	6.5	100	16	Zwart	62.90
HDPVC14G-100*	11.5	6.5	100	16	Groen	50.30
HDPVC14R-100*	11.5	6.5	100	16	Rood	50.30
HDPVC14B-100	11.5	6.5	100	16	Blauw	62.90
HDPVC14Y-100*	11.5	6.5	100	16	Geel	50.30
HDPVC516-100	13.5	8	100	16	Transparant	73.45
HDPVC516N-100	13.5	8	100	16	Zwart	66.10
HDPVC516G-100*	13.5	8	100	16	Groen	52.90
HDPVC516R-100*	13.5	8	100	16	Rood	52.90
HDPVC516B-100	13.5	8	100	16	Blauw	66.10
HDPVC516Y-100*	13.5	8	100	16	Geel	52.90
HDPVC38-50	16	10	50	15	Transparant	42.45
HDPVC38N-50	16	10	50	15	Zwart	45.10
HDPVC38B-50	16	10	50	15	Blauw	45.10
HDPVC38Y-50*	16	10	50	15	Geel	36.05
HDPVC12-50	18.5	12.5	50	12	Transparant	53.85
HDPVC12N-50	18.5	12.5	50	12	Zwart	53.85
HDPVC12G-50*	18.5	12.5	50	12	Groen	43.10
HDPVC12B-50	18.5	12.5	50	12	Blauw	53.85
HDPVC12Y-50*	18.5	12.5	50	12	Geel	43.10
HDPVC58-50	23	16	50	10	Transparant	64.70
HDPVC58N-50	23	16	50	10	Zwart	66.75
HDPVC58G-50*	23	16	50	10	Groen	53.40
HDPVC58R-50*	23	16	50	10	Rood	53.40
HDPVC58B-50	23	16	50	10	Blauw	66.75
HDPVC58Y-50*	23	16	50	10	Geel	53.40
RPVC34-20	25	19	20	10	Transparant	31.10
HDPVC34-50	26	20	50	10	Transparant	90.70
HDPVC34N-50	26	20	50	10	Zwart	90.70
HDPVC34G-50*	26	20	50	10	Groen	72.60
HDPVC34R-50*	26	20	50	10	Rood	72.60
HDPVC34B-50	26	20	50	10	Blauw	90.70
HDPVC34Y-50*	26	20	50	10	Geel	72.60
HDPVC1-50	33	25	50	10	Transparant	116.65
HDPVC1N-50	33	25	50	10	Zwart	116.65
HDPVC1G-50*	33	25	50	10	Groen	93.30
HDPVC1R-50*	33	25	50	10	Rood	93.30
HDPVC1B-50	33	25	50	10	Blauw	116.65
HDPVC1Y-50*	33	25	50	10	Geel	93.30
HDPVC516-10	14	8	10	16	Transparant	7.55
HDPVC516-20	14	8	20	16	Transparant	13.05
HDPVC38-10	16	10	10	15	Transparant	8.50
HDPVC38-20	16	10	20	15	Transparant	16.45

*Uitloopproduct

Hydrauliek
Snelkoppelingen
Afsluiters
Roestvast staal
Fittingen
Luchtconditionering
Gereedschap
Vacuumtechniek
Pneumatiek
Onderdelen compressoren
Diversen
Malleabele fittingen & Staal
Ringleidingssystemen
Slangen
Water, Gas, Sanitair, Verwarming

14 PVC Slangen



Hydrauliek Multifunctionele PVC slang - Medium Duty

Snelkoppelingen







Afsluiters  3 tot 15 bar

Roestvast staal  -20°C tot +55°C







Fittingen



Luchtconditionering PVC met textielinlage - 50 meter rollen - helder of gekleurd

Gereedschap							
Vacuümtechniek	RPVC532	9	4	50	13	Transparant	18.60
	RPVC14	11	6	50	15	Transparant	19.55
	RPVC14N	11	6	50	15	Zwart	20.60
Pneumatiek	RPVC14B	11	6	50	15	Blauw	20.60
	RPVC516	13	8	50	15	Transparant	23.10
Onderdelen compressoren	RPVC516N	13	8	50	15	Zwart	23.10
	RPVC516B	13	8	50	15	Blauw	23.10
Diversen	RPVC38	15	10	50	12	Transparant	28.10
	RPVC38N	15	10	50	12	Zwart	29.50
	RPVC38B	15	10	50	12	Blauw	29.50
Malleabele fittingen & Staal	RPVC12	18	13	50	12	Transparant	33.25
	RPVC12N	18	13	50	12	Zwart	33.75
	RPVC12B	18	13	50	12	Blauw	33.75
Ringleidingssystemen	RPVC58	21	16	50	10	Transparant	47.40
	RPVC58N	21	16	50	10	Zwart	45.25
Slangen	RPVC34	25	19	50	10	Transparant	55.10
	RPVC34N	25	19	50	10	Zwart	64.00
Water, Gas, Sanitair, Verwarming	RPVC34B	25	19	50	10	Blauw	64.00
	RPVC1	31	25	50	9	Transparant	76.20
	RPVC1N	31	25	50	9	Zwart	78.35
	RPVC114	40	32	50	6	Transparant	136.65
	RPVC112	46	38	50	5	Transparant	155.00
	RPVC2	60	50	50	3	Transparant	263.25





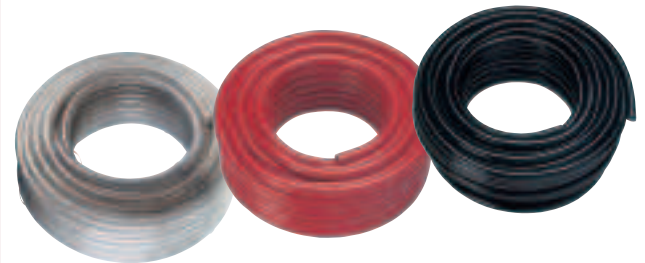

PVC met textielinlage - 30 meter rollen - helder of gekleurd

						
RPVC14Y*	11	6	30	15	Geel	11.20
RPVC38R*	15	10	30	12	Rood	15.65
RPVC12R*	18	13	30	12	Rood	18.85
RPVC12Y*	18	13	30	12	Geel	18.85

*Uitloopproduct



PVC met textielinlage - 100 meter rollen - helder of gekleurd

						
RPVC14-100	11	6	100	15	Transparant	64.65
RPVC14N-100	11	6	100	15	Zwart	64.65
RPVC14B-100	11	6	100	15	Blauw	64.65
RPVC14G-100*	11	6	100	15	Groen	51.70
RPVC14Y-100*	11	6	100	15	Geel	51.70
RPVC516-100	13	8	100	15	Transparant	86.20
RPVC516N-100	13	8	100	15	Zwart	86.20
RPVC516B-100	13	8	100	15	Blauw	86.20
RPVC38-100	15	10	100	12	Transparant	95.05
RPVC38N-100	15	10	100	12	Zwart	95.05
RPVC38B-100	15	10	100	12	Blauw	95.05
RPVC38Y-100*	15	10	100	12	Geel	76.00
RPVC12-100	18	13	100	12	Transparant	113.80
RPVC12N-100	18	13	100	12	Zwart	113.80
RPVC12B-100	18	13	100	12	Blauw	113.80
RPVC34-100	25	19	100	10	Transparant	200.90
RPVC1-100	31	25	100	9	Transparant	253.80

*Uitloopproduct

PVC Slangen



Refitex-Cristallo-Al voedingsmiddelen slang

Geschikt voor food en perslucht, multifunctionele slang voor industrie, chemicaliën zonder oplosmiddelen, laboratoria e.d. Levensmiddelenkwaliteit volgens de Europese normen.

Certificeerd: BAM, Laboratoire de recherches IANESCO prot. nr. 6851 en 6852,

Presidio Multizonale di Prevenzione di Vicenza, Prot. nr. 7825.

60°C max.

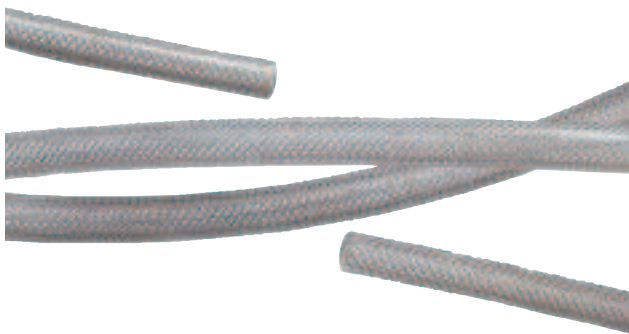

Refitex-Cristallo-Al - transparante universele PVC slang - voedingsmiddelen kwaliteit

PVC	OD mm	ID mm	L m	bar		€
23201206	12	6	100	20	Transparant	113.55
23201408	14	8	100	20	Transparant	138.00
23201610	16	10	50	20	Transparant	77.80
23201913	19	13	50	12	Transparant	97.05
23202216	22	16	50	10	Transparant	118.00
23202619	26	19	50	10	Transparant	162.55



CPVC slang, multifunctioneel - zonder weving

Zuiver PVC, zonder toevoegingen, zeer hoogwaardige kwaliteit.

Toepassingen: afvalwater, beluchting, bevoeiing, doceren, dranken, gassen, granulaten, poeders, voedingsmiddelen, water, zaaïen, enz.

Voedingskwaliteit (BS6066) USF & DA goedgekeurd materiaal.

De opgegeven druk is gebaseerd op een temperatuur van 20°C

1-3

-15°C tot +60°C

1/8" (6mm) t/m 3/4" (19mm)

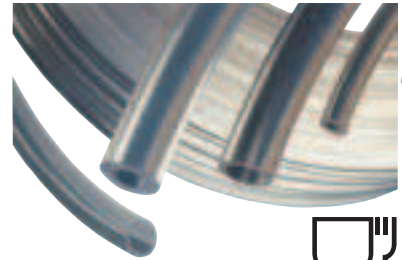

PVC slang helder - food - clear - un-reinforced - type CPVC

PVC	OD mm	ID mm	L m	ID		€
CPVC18/15-50	5	3	50	1/8"	Helder	6.30
CPVC532/10-50	6	4	50	5/32"	Helder	6.40
CPVC316/15-50	7	5	50	3/16"	Helder	7.65
CPVC14/15-50	8	6	50	1/4"	Helder	8.20
CPVC516/15-50	11	8	50	5/16"	Helder	17.05
CPVC38/15-50	12	9	50	3/8"	Helder	17.65
CPVC12/15-50	15	12	50	1/2"	Helder	23.20
CPVC34/15-50	22.5	19	50	3/4"	Helder	42.10



Turboflex - multifunctionele professionele PVC waterslang

PVC	mm	L m	ID	€
19351208	2,5	50	1/2"	88.95
19351913	3,1	50	3/4"	151.30
19352517	4	50	1"	252.95

- Hydrauliek
- Snelkoppelingen
- Afsluiters
- Roestvast staal
- Fittingen
- Luchtconditionering
- Gereedschap
- Vacuümtechniek
- Pneumatiek
- Onderdelen compressoren
- Diversen
- Malleabele fittingen & Staal
- Ringleidingssystemen
- Slangen
- Water, Gas, Sanitair, Verwarming

14 Polyamide spiraalslangen (Nylon 12) met rechte einden



Hydrauliek
Snelkoppelingen
Afsluiters
Roestvast staal
Fittingen
Luchtconditionering
Gereedschap
Vacuumtechniek
Pneumatiek
Onderdelen compressoren
Diversen
Malleabele fittingen & Staal
Ringleidingssystemen
Slangen
Water, Gas, Sanitair, Verwarming

Veiligheidsfactor: 3

Goed bestand tegen een breed scala aan chemicaliën
Olie en benzine bestendig / niet zuurbestendig



-40°C tot +80°C max.



Nylon-12-spiraalslang met rechte einden - BSPT

0306	ID mm	OD mm	W	BSPT	bar	€
N12C60402.5MB	4	6	2,5	1/4"	24	Blauw 10.35
N12C60405MB	4	6	5	1/4"	24	Blauw 13.50
N12C604010MB	4	6	10	1/4"	24	Blauw 19.80
N12C604015MB	4	6	15	1/4"	24	Blauw 25.25
N12C60402.5MR	4	6	2,5	1/4"	24	Rood 10.35
N12C60405MR	4	6	5	1/4"	24	Rood 13.50
N12C604010MR	4	6	10	1/4"	24	Rood 19.80
N12C604015MR	4	6	15	1/4"	24	Rood 25.25
N12C80602.5MB	6	8	2,5	1/4"	24	Blauw 11.55
N12C80605MB	6	8	5	1/4"	24	Blauw 15.90
N12C806010MB	6	8	10	1/4"	24	Blauw 23.85
N12C806015MB	6	8	15	1/4"	24	Blauw 32.25
N12C80602.5MR	6	8	2,5	1/4"	24	Rood 11.55
N12C80605MR	6	8	5	1/4"	24	Rood 15.90
N12C806010MR	6	8	10	1/4"	24	Rood 24.65
N12C806015MR	6	8	15	1/4"	24	Rood 33.30

0306	ID mm	OD mm	W	BSPT	bar	€
N12C100802.5MB	8	10	2,5	1/4"	15	Blauw 15.10
N12C100805MB	8	10	5	1/4"	15	Blauw 20.80
N12C1008010MB	8	10	10	1/4"	15	Blauw 32.10
N12C1008015MB	8	10	15	1/4"	15	Blauw 43.95
N12C100802.5MR	8	10	2,5	1/4"	15	Rood 15.10
N12C100805MR	8	10	5	1/4"	15	Rood 20.80
N12C1008010MR	8	10	10	1/4"	15	Rood 32.10
N12C1008015MR	8	10	15	1/4"	15	Rood 43.95
N12C120902.5MB	9	12	2,5	3/8"	17	Blauw 21.60
N12C120905MB	9	12	5	3/8"	17	Blauw 31.30
N12C1209010MB	9	12	10	3/8"	17	Blauw 50.70
N12C1209015MB	9	12	15	3/8"	17	Blauw 70.15
N12C120902.5MR	9	12	2,5	3/8"	17	Rood 21.60
N12C120905MR	9	12	5	3/8"	17	Rood 31.30
N12C1209010MR	9	12	10	3/8"	17	Rood 50.70
N12C1209015MR	9	12	15	3/8"	17	Rood 70.15

Spiraalslangen



PA-Nylon-12- gecalibreerde polyamide - spiraalslang / niet zuurbestendig / wel olie- en benzinebestendig

SPPA	OD mm	ID mm	W	L	Bar	€	
25350604	6	4	-	20	27	Rood	82.80
25360604	6	4	-	20	27	Blauw	82.80
25370604	6	4	1/4"	2.5	27	Rood	22.10
25380604	6	4	1/4"	2.5	27	Blauw	22.10
25390604	6	4	1/4"	5	27	Rood	30.85
25400604	6	4	1/4"	5	27	Blauw	30.85
25410604	6	4	1/4"	7.5	27	Rood	40.60
25420604	6	4	1/4"	7.5	27	Blauw	40.60
25430806	8	6	-	20	19	Rood	91.50
25440806	8	6	-	20	19	Blauw	91.50
25450806	8	6	1/4"	2.5	19	Rood	20.25
25460806	8	6	1/4"	2.5	19	Blauw	20.25
25470806	8	6	1/4"	5	19	Rood	32.35
25480806	8	6	1/4"	5	19	Blauw	32.35
25490806	8	6	1/4"	7.5	19	Rood	44.60
25500806	8	6	1/4"	7.5	19	Blauw	44.60
25510806	8	6	1/4"	10	19	Rood	56.70
25520806	8	6	1/4"	10	19	Blauw	56.70
25571008	10	8	-	20	15	Rood	109.75
25581008	10	8	-	20	15	Blauw	109.75
25591008	10	8	1/4"	2.5	15	Rood	24.35
25601008	10	8	1/4"	2.5	15	Blauw	24.35
25611008	10	8	1/4"	5	15	Rood	38.60
25621008	10	8	1/4"	5	15	Blauw	38.60
25631008	10	8	1/4"	7.5	15	Rood	53.20
25641008	10	8	1/4"	7.5	15	Blauw	53.20
25651008	10	8	1/4"	10	15	Rood	67.75
25661008	10	8	1/4"	10	15	Blauw	67.75
25671008	10	8	3/8"	2.5	15	Rood	28.10
25681008	10	8	3/8"	2.5	15	Blauw	28.10
25691008	10	8	3/8"	5	15	Rood	41.55
25701008	10	8	3/8"	5	15	Blauw	41.55
25711008	10	8	3/8"	7.5	15	Rood	56.35
25721008	10	8	3/8"	7.5	15	Blauw	56.35
25731008	10	8	3/8"	7.5	15	Rood	71.05
25741008	10	8	3/8"	10	15	Blauw	71.05
25751210	12	10	-	15	12	Blauw	109.35
25761210	12	10	3/8"	2.5	12	Blauw	34.70
25771210	12	10	3/8"	5	12	Blauw	54.00
25781210	12	10	3/8"	7.5	12	Blauw	72.45
25791210	12	10	3/8"	10	12	Blauw	89.90
25801210	12	10	3/8"	12.5	12	Blauw	112.65
25811210	12	10	3/8"	15	12	Blauw	131.70
25821512	15	12	-	15	12	Blauw	218.75
25831512	15	12	1/2"	2.5	12	Blauw	74.50
25841512	15	12	1/2"	5	12	Blauw	109.35
25851512	15	12	1/2"	7.5	12	Blauw	148.20
25861512	15	12	1/2"	10	12	Blauw	188.15
25871512	15	12	1/2"	12.5	12	Blauw	226.95
25881512	15	12	1/2"	15	12	Blauw	265.80

PA Spiraalslang met industriële JWJ snelkoppelingen, Orion profiel met stalen slotring en anti-knikveer. Industriële topkwaliteit.



PA-Nylon-12- gecalibreerde polyamide - spiraalslang met JWJ industriële snelkoppeling met Orion profiel

SPPA	OD mm	ID mm	W	L	Bar	€
26210604	6	4	2.5	27	Rood	40.15
26220604	6	4	2.5	27	Blauw	40.15
26240604	6	4	5	27	Rood	50.20
26250604	6	4	5	27	Blauw	50.20
26270604	6	4	7.5	27	Rood	60.25
26280604	6	4	7.5	27	Blauw	60.25
26330806	8	6	2.5	19	Rood	40.15
26340806	8	6	2.5	19	Blauw	40.15
26360806	8	6	5	19	Rood	51.60
26370806	8	6	5	19	Blauw	51.60
26390806	8	6	7.5	19	Rood	63.15
26400806	8	6	7.5	19	Blauw	63.15
26420806	8	6	10	19	Rood	74.60
26430806	8	6	10	19	Blauw	74.60

PA spiraalslang met industriële JWJ snelkoppelingen, Euro profiel met stalen slotring en anti-knikveer. Industriële topkwaliteit.

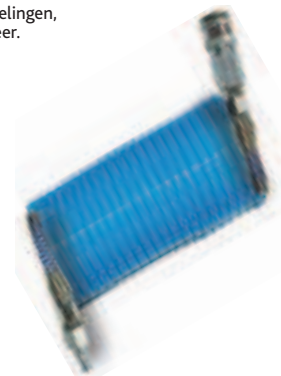

PA-Nylon-12- gecalibreerde polyamide - spiraalslang met JWJ industriële snelkoppeling met Euro profiel

SPPA	OD mm	ID mm	W	L	Bar	€
26510604	6	4	2.5	27	Rood	40.15
26520604	6	4	2.5	27	Blauw	40.15
26540604	6	4	5	27	Rood	50.20
26550604	6	4	5	27	Blauw	50.20
26570604	6	4	7.5	27	Rood	60.25
26580604	6	4	7.5	27	Blauw	60.25
26530806	8	6	2.5	19	Rood	40.15
26540806	8	6	2.5	19	Blauw	40.15
26570806	8	6	5	19	Rood	51.60
26560806	8	6	5	19	Blauw	51.60
26590806	8	6	7.5	19	Rood	63.15
26600806	8	6	7.5	19	Blauw	63.15
26620806	8	6	10	19	Rood	74.60
26630806	8	6	10	19	Blauw	74.60

- Hydrauliek
- Snelkoppelingen
- Afsluiters
- Roestvast staal
- Fittingen
- Luchtconditionering
- Gereedschap
- Vacuümtechniek
- Pneumatiek
- Onderdelen compressoren
- Diversen
- Malleabele fittingen & Staal
- Ringleidingssystemen
- Slangen
- Water, Gas, Sanitair, Verwarming

14 Spiraalslangen



Hydrauliek

Blaasset

Snelkoppelingen

PU spiraalslang met industriële JWL snelkoppelingen, Orion profiel met stalen slotring en anti-knikveer. Inclusief JWL Airboy blaaspistool. Industriële topkwaliteit.

Afsluiters

Roestvast staal

Fittingen

Luchtconditionering

Gereedschap

PU - blaasset met rechte einden, draaibare koppelingen & insteeknippel - Orion profiel

SPSK	OD mm	ID mm	-m-	bar		€
28500805	8	5	4	12	Blauw	80.20
28510805	8	5	6	12	Blauw	88.25
28520805	8	5	8	12	Blauw	96.75

Pneumatiek

Onderdelen compressoren

Diversen

PU spiraalslang met industriële JWL snelkoppelingen, Euro profiel met stalen slotring en anti-knikveer. Inclusief JWL Airboy blaaspistool. Industriële topkwaliteit.

Malleabele fittingen & Staal

Ringleidingssystemen

Slangen

Water, Gas, Sanitair, Verwarming

PU - blaasset met rechte einden, draaibare koppelingen & insteeknippel - Euro profiel

SPSK	OD mm	ID mm	-m-	bar		€
28600805	8	5	4	12	Blauw	77.80
28610805	8	5	6	12	Blauw	88.25
28620805	8	5	8	12	Blauw	96.75

PU - gec calibreerde industriële spiraalslang met rechte einden - elastisch & knikvrij - zonder koppelingen

SPSK	OD mm	ID mm	-m-	bar		€
28200805	8	5	4	12	Blauw	39.15
28210805	8	5	6	12	Blauw	45.60
28220805	8	5	8	12	Blauw	54.40
28261065	10	6.5	2	12	Blauw	33.05
28271065	10	6.5	4	12	Blauw	47.00
28281065	10	6.5	6	12	Blauw	59.65
28291065	10	6.5	8	12	Blauw	72.45
28231208	12	8	4	12	Blauw	56.70
28241208	12	8	6	12	Blauw	74.50
28251208	12	8	8	12	Blauw	92.20

PU spiraalslang met draaibare koppelingen met anti-knikveer. Industriële topkwaliteit.

PU - gec calibreerde industriële spiraalslang met draaibare anti-knik koppelingen - elastisch & knikvrij

SPSK	OD mm	ID mm	-m-	bar		€	
28300805	8	5	1/4"	4	12	Blauw	54.40
28310805	8	5	1/4"	6	12	Blauw	60.35
28320805	8	5	1/4"	8	12	Blauw	71.30
28361065	10	6.5	1/4"	2	12	Blauw	50.80
28371065	10	6.5	1/4"	4	12	Blauw	67.30
28381065	10	6.5	1/4"	6	12	Blauw	78.25
28391065	10	6.5	1/4"	8	12	Blauw	94.70
28331208	12	8	3/8"	4	12	Blauw	81.00
28341208	12	8	3/8"	6	12	Blauw	94.70
28351208	12	8	3/8"	8	12	Blauw	116.80

Met industriële JWL snelkoppelingen, Orion profiel met metalen slotring. Ook met Euro profiel leverbaar.

PU - gec calibreerde industriële spiraalslang met JWL Orion snelkoppeling en insteeknippel en draaibare anti-knik koppelingen - elastisch en knikvrij

SPSK	OD mm	ID mm	-m-	bar		€
28400805	8	5	4	12	Blauw	72.75
28410805	8	5	6	12	Blauw	79.55
28420805	8	5	8	12	Blauw	89.15
28461065	10	6.5	2	12	Blauw	71.30
28471065	10	6.5	4	12	Blauw	86.20
28481065	10	6.5	6	12	Blauw	96.05
28491065	10	6.5	8	12	Blauw	108.40
28431208	12	8	4	12	Blauw	98.80
28441208	12	8	6	12	Blauw	112.55
28451208	12	8	8	12	Blauw	128.15

Spiraalslangen



PU - gecalibreerde industriële spiraalslang met draaibare kunststof anti-knik koppelingen - elastisch & knikvrij

	SPSK	OD mm	ID mm	W - m -	bar		€
85KK14-4		8	5	1/4"	4	12	Blauw 58.85
85KK14-6		8	5	1/4"	6	12	Blauw 68.10
85KK14-8		8	5	1/4"	8	12	Blauw 77.45
1065KK14-2		10	6.5	1/4"	2	12	Blauw 56.10
1065KK14-4		10	6.5	1/4"	4	12	Blauw 70.80
1065KK14-6		10	6.5	1/4"	6	12	Blauw 84.10
1065KK14-8		10	6.5	1/4"	8	12	Blauw 97.70
1208KK14-4		12	8	1/4"	4	12	Blauw 82.35
1208KK14-6		12	8	1/4"	6	12	Blauw 98.80
1208KK14-8		12	8	1/4"	8	12	Blauw 116.80
1208KK38-4		12	8	3/8"	4	12	Blauw 82.35
1208KK38-6		12	8	3/8"	6	12	Blauw 98.60
1208KK38-8		12	8	3/8"	8	12	Blauw 117.95
1611KK12-3		16	11	1/2"	3	10	Blauw 160.20
1611KK12-6		16	11	1/2"	6	10	Blauw 192.45
1611KK12-8		16	11	1/2"	8	10	Blauw 216.90
1913KK34-3		19	13	3/4"	3	10	Blauw 222.50
1913KK34-6		19	13	3/4"	6	10	Blauw 264.75
1913KK34-8		19	13	3/4"	8	10	Blauw 294.80



LÜDECKE 14

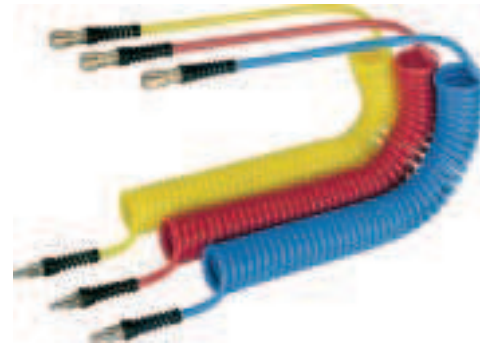

PU - gecalibreerde industriële spiraalslang met JWL Euro veiligheidssnelkoppeling en insteeknippel en kunststof draaibare (360°) anti-knik koppelingen - elastisch & knikvrij

	SPSK	OD mm	ID mm	W - m -	bar		€
85KEURO-4		8	5	4	12	Blauw	82.35
85KEURO-6		8	5	6	12	Blauw	91.35
85KEURO-8		8	5	8	12	Blauw	100.90
1065KEURO-2		10	6.5	2	12	Blauw	79.90
1065KEURO-4		10	6.5	4	12	Blauw	94.10
1065KEURO-6		10	6.5	6	12	Blauw	107.60
1065KEURO-8		10	6.5	8	12	Blauw	120.15
1208KEURO-4		12	8	4	12	Blauw	105.70
1208KEURO-6		12	8	6	12	Blauw	122.35
1208KEURO-8		12	8	8	12	Blauw	140.20



Lüdecke draaibare inschroefkoppeling met kunststof anti-knikveer & PTFE voorgecoat BSP buitendraad voor o.a. spiraalslang

	SPSK	OD mm	ID mm	BSPP	€
DVK5814		8	5	1/4"	10.90
DVK651014		10	6.5	1/4"	11.60
DVK81214		12	8	1/4"	12.25
DVK81238		12	8	3/8"	12.25
DVK11612		16	11	1/2"	27.60
SVS131934		19	13	3/4"	23.80

Hydrauliek
Snelkoppelingen
Afsluiters
Roestvast staal
Fittingen
Luchtconditionering
Gereedschap
Vacuumtechniek
Pneumatiek
Onderdelen compressoren
Diversen
Malleabele fittingen & Staal
Ringleidingssystemen
Slangen
Water, Gas, Sanitair, Verwarming



14 Spiraalslangen



Hydrauliek **PU anti-knik spiraalslang met swivel koppelingen**

Snelkoppelingen Ongeveer 15% lichter dan standaard zuigslang.
Toepassingen: Algemene pomp en zuig-toepassingen in de landbouw, industrie en bouw.
Afsluiters Media: Water, slib, drijfmest, chemicaliën en afvalstoffen.
Drukgegevens gelden bij: 20°C / veiligheidsfactor: 3
Roestvast staal Temperatuur boven 20°C resulteren in een daling van de werkdruk.

Fittingen 10

Luchtconditionering 0°C tot +50°C

Gereedschap

Vacuumtechniek

Pneumatiek

Onderdelen compressoren

Diversen

Malleabele fittingen & Staal

Ringleidingssystemen

Slangen

Water, Gas, Sanitair, Verwarming

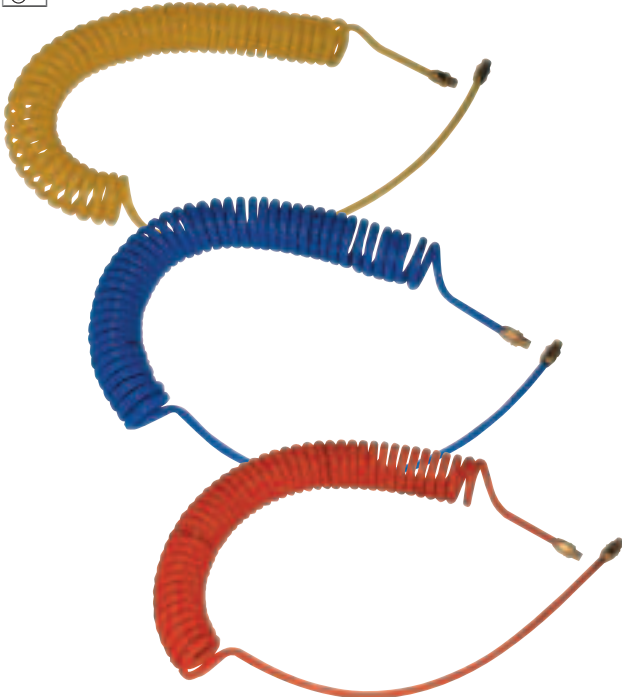

PU-spiraalslang met rechte einden & draaibare koppelingen

28800604	6	4	Geel	1/4"	2	11.05
28810604	6	4	Geel	1/4"	4	13.90
28801065	10	6.5	Geel	1/4"	2	16.60
28811065	10	6.5	Geel	1/4"	4	21.05
28821065	10	6.5	Geel	1/4"	6	27.60
28831065	10	6.5	Geel	1/4"	8	35.65
28801208	12	8	Geel	3/8"	2	25.45
28811208	12	8	Geel	3/8"	4	27.20
28821208	12	8	Geel	3/8"	6	41.80
28831208	12	8	Geel	3/8"	8	49.20
28860604	6	4	Blauw	1/4"	2	10.80
28870604	6	4	Blauw	1/4"	4	13.00
28861065	10	6.5	Blauw	1/4"	2	14.25
28871065	10	6.5	Blauw	1/4"	4	19.90
28881065	10	6.5	Blauw	1/4"	6	27.70
28891065	10	6.5	Blauw	1/4"	8	31.65
28901208	12	8	Blauw	3/8"	2	25.30
28911208	12	8	Blauw	3/8"	4	28.20
28921208	12	8	Blauw	3/8"	6	41.80
28931208	12	8	Blauw	3/8"	8	48.85
28980604	6	4	Rood	1/4"	2	11.05
28910604	6	4	Rood	1/4"	4	13.65
28800805	8	5	Rood	1/4"	2	9.60
28810805	8	5	Rood	1/4"	4	11.95
28820805	8	5	Rood	1/4"	6	15.50
28830805	8	5	Rood	1/4"	8	17.30
28840805	8	5	Rood	1/4"	10	22.95
28850805	8	5	Rood	1/4"	12	25.95
28961065	10	6.5	Rood	1/4"	2	14.80
28971065	10	6.5	Rood	1/4"	4	21.05
28981065	10	6.5	Rood	1/4"	6	27.70
28991065	10	6.5	Rood	1/4"	8	33.75
28901065	10	6.5	Rood	1/4"	10	45.30
28911065	10	6.5	Rood	1/4"	12	49.85
28701208	12	8	Rood	3/8"	2	22.75
28711208	12	8	Rood	3/8"	4	30.45
28721208	12	8	Rood	3/8"	6	42.50
28731208	12	8	Rood	3/8"	8	48.50
28741208	12	8	Rood	3/8"	10	64.95
28751208	12	8	Rood	3/8"	12	72.55

Spiraalslangen



PU spiraalslang

Zeer lage buigradius.



12 bar bij 20°C



-20°C tot +75°C

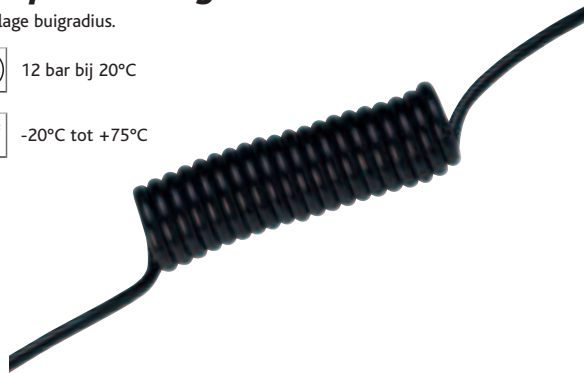

PU spiraalslang met rechte einden - elastisch & knikvrij - oliebestendig / niet zuurbestendig, poly coil



	ID mm	OD mm	Wavy line	B mm	Diagonal lines	Euro
PUC6/1	4	6	1	37	Zwart	3.25
PUC6/2	4	6	2	37	Zwart	5.05
PUC6/3	4	6	3	37	Zwart	6.65
PUC8/2	5	8	2	47	Zwart	6.65
PUC8/5	5	8	5	47	Zwart	13.20
PUC6/2B	4	6	2	37	Blauw	5.25
PUC6/3B	4	6	3	37	Blauw	6.65
PUC8/2B	5	8	2	47	Blauw	6.65
PUC8/3B	5	8	3	47	Blauw	8.50
PUC8/5B	5	8	5	47	Blauw	13.20

Heavy duty gewapende PU spiraal met draaibare koppelingen. Aansluiting BSP 1/4" male swivels.



12 bar bij 20°C



-20°C tot +75°C

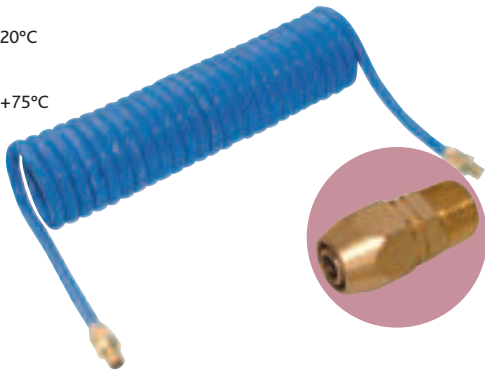

PU / polyester versterkte industriële heavy duty spiraalslang met draaibare koppelingen, knikvrij & zeer slijtvast



	OD mm	ID mm	Zigzag	Wavy line	Euro
28841065	10	6.5	1/4"	5	30.85
28851065	10	6.5	1/4"	7.5	42.20
28841208	12	8	1/4"	5	44.35
28851208	12	8	1/4"	7.5	59.50

PA DUO spiraalslang



PA-11/12-gecalibreerde duo-spiraal /niet zuurbestendig / wel olie- & benzinebestendig



	OD mm	ID mm	Diagonal lines	Wavy line	Euro
18890604	6	4	Zwart/Blauw	10	117.95
18890806	8	6	Zwart/Blauw	10	131.20
18891008	10	8	Zwart/Blauw	10	189.60



Gecalibreerde diffusiedichte mantelpijp met aluminium tussenlaag - voor CV & sanitair - zeer geschikt voor korte bochten (voor gebruik met push-in fittingen) - per rol



	OD mm	Pressure	L m	Euro
14001050	10	12	50	156.35
140012100	12	12	100	303.90
14001525	15	11	25	94.75
14001550	15	11	50	181.30
140015100	15	11	100	339.60
14002225	22	10	25	174.50
14002250	22	10	50	349.00

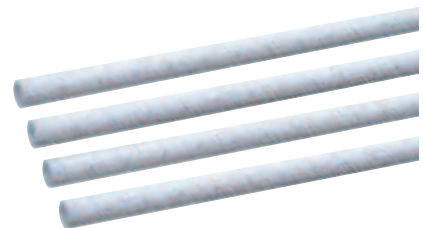

Gecalibreerde diffusiedichte mantelpijp met aluminium tussenlaag - voor CV & sanitair (voor gebruik met push-in fittingen) - per lengte van 3 meter



	OD mm	Pressure	L m	Euro
1400153M	15	11	3	9.45
1400223M	22	10	3	18.50

Standaard bundels van 20 lengtes van 3 meter; genoemde prijs is per lengte

- Hydrauliek
- Snelkoppelingen
- Afsluiters
- Roestvast staal
- Fittingen
- Luchtconditionering
- Gereedschap
- Vacuümtechniek
- Pneumatiek
- Onderdelen compressoren
- Diversen
- Malleabele fittingen & Staal
- Ringleidingssystemen
- Slangen
- Water, Gas, Sanitair, Verwarming

14 Buizen



kiwa



- Hydrauliek
- Snelkoppelingen
- Afsluiters
- Roestvast staal
- Fittingen
- Luchtconditionering
- Gereedschap
- Vacuumtechniek
- Pneumatiek
- Onderdelen compressoren
- Diversen
- Malleabele fittingen & Staal
- Ringleidingssystemen
- Slangen
- Water, Gas, Sanitair, Verwarming



Koperen buis (Sf Cu) lengtes van 3 meter - volgens en 1057 - Kiwa en Gastec keur

KOPB	OD mm	ID mm	bar	bar	L m	€
KKOPB12	12	10	25	100	3	Op aanvraag
KKOPB15	15	13	20	80	3	Op aanvraag
KKOPB22	22	19.8	15	60	3	Op aanvraag
KKOPB28	28	25.6	12	50	3	Op aanvraag



Gegloeide koperen buis op rollen van 10 of 30 meter, keur BS2871/2/C106 (en 1057)

KOPB	OD mm	ID mm	bar	bar	L m	€
MCT-4	4	2.8	189	758	10	Koper Op aanvraag
MCT-4/30	4	2.8	189	758	30	Koper Op aanvraag
MCT-6	6	4.4	172	689	10	Koper Op aanvraag
MCT-6/30	6	4.4	172	689	30	Koper Op aanvraag
MCT-8	8	6.4	120	482	10	Koper Op aanvraag
MCT-8/30	8	6.4	120	482	30	Koper Op aanvraag
MCT-10	10	8.4	80	344	10	Koper Op aanvraag
MCT-10/30	10	8.4	80	344	30	Koper Op aanvraag
MCT-12	12	10.4	68	275	10	Koper Op aanvraag
MCT-12/30	12	10.4	68	275	30	Koper Op aanvraag



Aluminium buis met blauwe oppervlak coating 20 bar - lengtes van 3 meter

KOPB	OD mm	ID mm	bar	L m	€
AL-RM1512-3M	15	13	Blauw	3	21.55
AL-RM1814-3M	18	16	Blauw	3	30.60
AL-RM2218-3M	22	20	Blauw	3	32.20
AL-RM2823-3M	28	26	Blauw	3	51.90

Aluminium elektrostatisch gecoate blauwe 15 bar persluchtleding - lengtes van 4 meter

KOPB	OD mm	ID mm	bar	L m	€
97772015	20	17	Blauw	4	20.80
97772515	25	22	Blauw	4	28.40
97773215	32	29	Blauw	4	37.05
97774015	40	37	Blauw	4	48.35
97775020	50	46	Blauw	4	74.00
97776320	63	59	Blauw	4	94.90

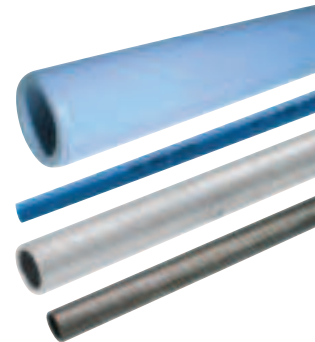

Voor PVR buizen en polyamide buizen zie hoofdstuk 13

Voor hogedruk precisie buis zie hoofdstuk 1

Voor gasbuis in lengtes van 6 meter zie hoofdstuk 12

Leidingknippers

Leidingkniptangen, groot & klein

Deze verbeterde verchromde metalen leidingkniptang met verwisselbare mesjes van gehard staal, snijdt slangen van PA, PE, PU, PPC, Vinylnan, PVC en andere plastics en rubber perfect, keer op keer.

Een onmisbaar stuk gereedschap.

De kleine tang knipt van klein tot 16 mm. De grote tang knipt perfect tot 28 mm.

Wordt veel toegepast in pneumatiek, hydrauliek, gas, water, elektra en in de algemene installatietechniek.



Leidingkniptang - Metaal - Klein



27000216

Kniptang voor leiding van 2-12mm

16.30

Leidingkniptang - Metaal - Groot



27000825

Kniptang voor leiding van 4-28mm

23.60

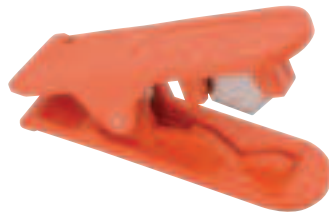

Leidingknipper - Kunststof



27000414

Leidingknipper 4-14mm rood

2.70

Mesje voor leidingknippers



27010414

Mesje voor kunstst leidingknipper 4-14mm

2.95

27010216

Mesje voor metalen leidingkniptang 2-16mm

4.95

27010825

Mesje voor metalen leidingkniptang 4-28mm

7.40

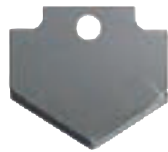

Pijpsnijder voor pijpen & buizen van 3 tot 30mm



CTC-1

Standaard cutter 3-30mm

6.45

Slang & buisknipper voor slangen & PVC / PVR buizen tot 35mm



LBS-120

Tube knipper tot 35mm

46.00



Pijpsnijder voor pijpen & buizen van 3 tot 16mm



CTC-2

Mini cutter 3-16mm

7.20

Hydrauliek

Snelkoppelingen

Afsluiters

Roestvast staal

Fittingen

Luchtconditionering

Gereedschap

Vacuümtechniek

Pneumatiek

Onderdelen compressoren

Diversen

Malleabele fittingen & Staal

Ringleidingssystemen

Slangen

Water, Gas, Sanitair, Verwarming

14 Werkplaatsslang met koppelingen



Hydrauliek **Slang assemblies**

Snelkoppelingen Samengestelde slangen voor industrieel en professioneel gebruik. Andere combinaties zijn op aanvraag leverbaar.



Fittingen HD-PVC-slang met textiel inlage, gemonteerd met snelkoppeling & insteeknippel, Euro profiel

Luchtconditionering

516-EP10	14	8	5/16"	10	16	Transparant	18.60
38-EP10	16	10	3/8"	10	15	Transparant	19.00
516-EP20	14	8	5/16"	20	16	Transparant	28.10
38-EP20	16	10	3/8"	20	15	Transparant	30.25



Malleabele fittingen & Staal HD-PVC slang textiel inlage, gemonteerd met snelkoppeling & insteeknippel, Orion profiel

Ringleidingssystemen

516-OP10	14	8	5/16"	10	16	Transparant	18.60
38-OP10	16	10	3/8"	10	15	Transparant	19.15
516-OP20	14	8	5/16"	20	16	Transparant	28.10
38-OP20	16	10	3/8"	20	15	Transparant	30.25

Slangen **Water, Gas, Sanitair, Verwarming**



HD-PVC, met textiel inlage gemonteerd met klauwkoppelingen perslucht ID. 19mm

ASS icon **OD icon** **ID icon** **L icon** **bar icon** **€ icon**

34-KKP20	25	19	3/4"	20	10	Transparant	46.60
-----------------	----	----	------	----	----	-------------	--------------



HD-PVC slang, textiel inlage compleet met messing klauwkoppelingen (voor water) ID. 19mm

ASS icon **OD icon** **ID icon** **L icon** **bar icon** **€ icon**

34-KKW20	25	19	3/4"	20	10	Transparant	49.35
-----------------	----	----	------	----	----	-------------	--------------



Ultralichte zeer elastische PU slang met polyester inlage, compleet gemonteerd met heavy duty Euro - snelkoppeling en geharde nippel ID 7.5mm

ASS icon **OD icon** **ID icon** **L icon** **bar icon** **€ icon**

18020805E	12	8	5	20	Groen	41.35
18020875E	12	8	7.5	20	Groen	52.10
18020810E	12	8	10	20	Groen	62.85
18020820E	12	8	20	20	Groen	105.55



Ultralichte zeer elastische PU slang met polyester inlage, compleet gemonteerd met heavy duty Orion - snelkoppeling en geharde nippel ID 5.5mm

ASS icon **OD icon** **ID icon** **L icon** **bar icon** **€ icon**

18020805O	12	8	5	20	Groen	41.35
18020875O	12	8	7.5	20	Groen	52.10
18020810O	12	8	10	20	Groen	62.85
18020820O	12	8	20	20	Groen	105.55



CEJN-320S PU slang - streamline - gemonteerd met CEJN-veiligheidsnippelkoppeling & nippel, Euro profiel - superveilig

ASS icon **OD icon** **ID icon** **L icon** **bar icon** **€ icon**

18320805E	12	8	5	20	Blauw	83.40
18320875E	12	8	7.5	20	Blauw	101.35
18320810E	12	8	10	20	Blauw	119.35
18320820E	12	8	20	20	Blauw	191.10

Staalomvlochten slang & accessoires



14

Bundelspiraal

Voor het bundelen en/of beschermen van slangen of kabels.



Zwart is de standaard kleur. Op aanvraag zijn ook blauw en naturel leverbaar.



Code	ID mm	L m	Kleur	€
28210604	6-20	50	Zwart	35.80
28210806	8-40	50	Zwart	41.70
28211008	10-45	50	Zwart	66.70
28211209	12-50	50	Zwart	88.15

Slangen EPDM en NITRIEL met accessoires

De opgegeven druk is gebaseerd op een temperatuur van 20°C



-20°C tot 80°C

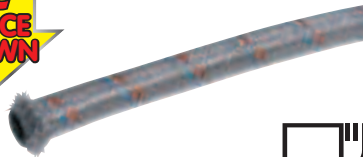

Nitriël rubber slang - met gegalvaniseerde omvlechting - 30 meter rollen



Code	Druk (bar)	L m	ID mm	OD mm	€
GOB-6	15	30	6	10	152.10
GOB-8	15	30	8	13	168.30
GOB-10	15	30	10	15	200.00
GOB-13	10	30	13	19	217.80



-20°C tot 100°C



EPDM rubber slang - met RVS 304 omvlechting - 30 meter rollen



Code	Druk (bar)	L m	ID mm	OD mm	€
SOB-8	15	30	8	12	213.30
SOB-10	15	30	10	14	229.50
SOB-13	15	30	13	18	256.40
SOB-16	12	30	16	22	431.65
SOB-19	10	30	19	27	493.20
SOB-25	10	30	25	34	639.90



Messing vernikkeld

Inschroeffitting - slangpilaar x BSPT male



Code	BSPT	ID mm	€
MC1/8-6	1/8"	6	2.70
MC1/4-6	1/4"	6	2.85
MC1/4-8	1/4"	8	2.65
MC3/8-8	3/8"	8	2.05
MC1/2-8	1/2"	8	6.05
MC3/4-8	3/4"	8	4.40
MC3/8-10	3/8"	10	1.90
MC1/2-10	1/2"	10	3.35
MC3/4-10	3/4"	10	4.60
MC3/8-13	3/8"	13	2.20
MC1/2-13	1/2"	13	3.50
MC3/4-13	3/4"	13	6.20
MC1/2-16	1/2"	15	3.95
MC3/4-15	3/4"	15	5.50
MC3/4-19	3/4"	19	6.30
MC1-25	1"	25	11.80

Opschroeffitting - slangpilaar x BSP female (bolconische dichting)



Code	BSP	ID mm	€
FO1/8-6	1/8"	6	3.35
FO1/4-6	1/4"	6	3.40
FO3/8-6	3/8"	6	4.95
FO1/4-8	1/4"	8	3.40
FO3/8-8	3/8"	8	2.20
FO3/8-10	3/8"	10	3.60
FO1/2-10	1/2"	10	2.85
FO3/8-13	3/8"	13	3.65
FO1/2-13	1/2"	13	4.15
FO1/2-16	1/2"	16	4.60
FO3/4-16	3/4"	16	6.65
FO3/4-19	3/4"	19	6.15
FO1-25	1"	25	8.75

Opschroeffitting - slangpilaar x BSP female (vlakke dichting) / wordt geleverd zonder O-Ring



Code	BSP	ID mm	€
FP3/8-8BX	3/8"	8	2.05
FP1/2-8BX	1/2"	8	3.00
FP3/8-10BX	3/8"	10	2.00
FP1/2-10BX	1/2"	10	3.35
FP3/4-10BX	3/4"	10	4.70
FP3/8-13BX	3/8"	13	3.00
FP1/2-13BX	1/2"	13	3.45
FP3/4-13BX	3/4"	13	4.60
FP1/2-16BX	1/2"	16	4.20
FP3/4-16BX	3/4"	16	5.25
FP3/4-19BX	3/4"	19	6.00
FP1-19BX	1"	19	8.95
FP1-25BX	1"	25	9.75

O-ringen t.b.v. deze fittingen vindt u verderop in dit hoofdstuk

Hydrauliek

Snelkoppelingen

Afsluiters

Roestvast staal

Fittingen

Luchtconditionering

Gereedschap

Vacuümtechniek

Pneumatiek

Onderdelen compressoren

Diversen

Malleabele fittingen & Staal

Ringleidingssystemen

Slangen

Water, Gas, Sanitair, Verwarming

14 Staalomvlochten slang & accessoires

Hydrauliek  Messing vernikkeld

Snelkoppelingen

Afsluiters Opschroeffitting - slangpilaar 90° knie x BSP female (bolconische dichting)

Roestvast staal	EPDM	BSPP	ID mm	€
FON1/4-6		1/4"	6	4.05
FON1/4-8		1/4"	8	4.15
FON3/8-8		3/8"	8	7.00
FON3/8-10		3/8"	10	7.90
FON1/2-10		1/2"	10	7.90
FON1/2-13		1/2"	13	8.20
FON3/4-16		3/4"	16	10.10
FON3/4-19		3/4"	19	11.00
FON1-25		1"	25	26.85

Pneumatiek

Onderdelen compressoren Opschroeffitting - slangpilaar 90° knie x BSP female (vlakke dichting) / wordt geleverd zonder O-Ring

Diversen	EPDM	BSPP	ID mm	€
FPN3/8-8		3/8"	8	5.25
FPN1/2-8		1/2"	8	8.50
FPN3/4-8		3/4"	8	9.05
FPN3/8-10		3/8"	10	7.55
FPN1/2-10		1/2"	10	7.70
FPN3/4-10		3/4"	10	11.00
FPN1/2-13		1/2"	13	8.50
FPN3/4-13		3/4"	13	9.65
FPN3/4-16		3/4"	16	13.75
FPN3/4-19		3/4"	19	14.90
FPN1-25		1"	25	26.45

O-ringen t.b.v. deze fittingen vindt u verderop in dit hoofdstuk

Knelfitting - slangpilaar x knelring

EPDM	ID mm	OD mm	€
MB15-10BX	10	15	6.60
MB15-13BX	13	15	6.75
MB22-13BX	13	22	9.45
MB22-19BX	19	22	13.30

Steenpipel - slangpilaar x steel

EPDM	ID mm	OD mm	€
HCL8-6	6	8	5.80
HCL10-8	8	10	4.85
HCL10-10	10	10	6.00
HCL10-12	10	12	4.95
HCL12	12	12	5.10
HCL12-15 (blank messing)	12	15	5.45
HCL22-19 (blank messing)	19	22	7.50

Krimphuls - aluminium

EPDM	GAT mm	HULS mm	HULS mm	€
B12X14	9	12	14	0.60
B13X15	9	13	15	0.60
B14X16	9,5	14	16	0.60
B16X18	12	16	18	0.60
B18X20	13	18	20	0.85
B20X22	15	20	22	0.85
B21X23	15	21	23	0.85
B23X25	17	23	25	2.40
B26X28	20	26	28	2.40
B28X30	19	28	30	2.60
B33X35	26	33	35	2.85
B36X38	26	36	38	2.95



Krimphuls - RVS

EPDM	GAT mm	HULS mm	HULS mm	€
B11X12SS	8	11	12	0.50
B13X14SS	9,3	13	14	0.80
B18X19SS	14	18,5	19,5	1.00
B15X16SS	11	15	16	1.55
B23X25SS	17	23	25	2.80
B29X30SS	21	29	30	3.80
B36X38SS	29	36	38	6.00

Krimphuls - vernikkeld staal

EPDM	GAT mm	HULS mm	HULS mm	€
HS9X55	5,5	9	10	0.25
HS10X65	6,5	10	11	0.25
HS11X65	6,5	11	12	0.25
HS11X75	7,5	12	13	0.30
HS12X12	12	12,5	13,5	0.50
HS125X10	10	12,5	13,5	0.30
HS135X75	7,5	13,5	14,5	0.30
HS135X10	10	13,5	14,5	0.30
HS14X10	10	14	16	0.30
HS145X117	11,7	14,5	16,5	0.35
HS15X10	10	15	17	0.30
HS15X117	11,7	15	17	0.30
HS16X117	11,7	16	18	0.30
HS17X117	11,7	17	19	0.40
HS18X138	13,8	18	20	0.50
HS19X138	13,8	19	21	0.55
HS20X138	13,8	20	22	0.50
HS22X156	15,6	22	24	0.65
HS23X17	17	23	25	0.80
HS245X17	17	24,5	26,5	0.80
HS265X195	19,5	26,5	28,5	0.85
HS28X205	20,5	28	30	1.05
HS30X24	24	30	32	1.95
HS32X24	24	32	34	1.95
HS33X24	24	33	35	2.15
HS34X24	24	34	36	2.50
HS36X25	25	36	38	2.70
HS38X27	27	38	40	3.25
HS40X28	28	40	42	3.70
HS45X35	35	45	47	3.90

Staalomvlochten slang & accessoires

EPDM & fiber dichtingsringen voor fittingen t.b.v. omvlochten slang met vlakke dichting



15-8-2MM	EPDM Ring 8 x 2mm	3/8"	0.30
19-10-2MM	EPDM Ring 10 x 2mm	1/2"	0.30
24-14-2MM	EPDM Ring 14 x 2mm	3/4"	0.30
G12	Fiber Ring 1/2"	1/2"	0.30
G1	Fiber Ring 1"	1"	0.50
G112	Fiber Ring 1.1/2"	1.1/2"	0.60
G2	Fiber Ring 2"	2"	0.75



Hand krimpmachine voor het persen van de hulzen en koppelingen op staalomvlochten slang - alleen geschikt voor kleinere maten (3 - 24mm)



UPS1



1532.05



Hydrauliek

Snelkoppelingen

Afsluiters

Roestvast staal

Fittingen

Luchtconditionering

Gereedschap

Vacuümtechniek

Pneumatiek

Onderdelen compressoren

Diversen

Malleabele fittingen & Staal

Ringleidingssystemen

Slangen

Water, Gas, Sanitair, Verwarming

Tie wraps



RVS-304 tie wraps



	B mm	L mm	
STW-201L	4,6	201	1.35
STW-362L	4,6	362	1.65
STW-679L	4,6	679	2.40
STW-259H	7,9	259	2.60
STW-838H	7,9	838	4.15

UV-, olie-, vet-, zout- (DNV marine) en licht zuur bestendig. UL goedgekeurd (E97527).

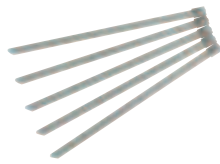

PA6/6 tie wraps - wit - per 100 stuks



	B mm	L mm	
GP-025-0100N	2,5	100	0.75
GP-025-0200N	2,5	200	2.15
GP-036-0140N	3,6	140	2.40
GP-036-0200N	3,6	200	3.60
GP-036-0300N	3,6	300	5.30
GP-048-0120N	4,8	120	3.35
GP-048-0160N	4,8	160	3.60
GP-048-0200N	4,8	200	3.60
GP-048-0300N	4,8	300	5.40
GP-048-0368N	4,8	368	7.25
GP-076-0200N	7,6	200	20.00
GP-076-0240N	7,6	240	12.35
GP-076-0300N	7,6	300	12.35
GP-076-0368N	7,6	368	17.30
GP-090-0430N	9,0	430	27.20
GP-090-0530N	9,0	530	34.60



PA6/6 tie wraps - zwart - per 100 stuks



	B mm	L mm	
GP-025-0200B	2,5	200	2.15
GP-036-0140B	3,6	140	2.40
GP-036-0200B	3,6	200	3.60
GP-036-0300B	3,6	300	5.30
GP-048-0120B	4,8	120	3.35
GP-048-0160B	4,8	160	3.60
GP-048-0200B	4,8	200	3.60
GP-048-0300B	4,8	300	5.40
GP-048-0368B	4,8	368	7.25
GP-076-0200B	7,6	200	20.00
GP-076-0240B	7,6	240	12.35
GP-076-0300B	7,6	300	12.35
GP-076-0368B	7,6	368	17.30
GP-090-0430B	9,0	430	27.20
GP-090-0530B	9,0	530	34.60



14 Hydrauliek slang



- Hydrauliek
- Snelkoppelingen
- Afsluiters
- Roestvast staal
- Fittingen
- Luchtconditionering
- Gereedschap
- Vacuumtechniek
- Pneumatiek
- Onderdelen compressoren
- Diversen
- Malleabele fittingen & Staal
- Ringleidingssystemen
- Slangen
- Water, Gas, Sanitair, Verwarming

Flexibele kwaliteits slang, los of geperst met stalen slangkoppelingen en hulzen.
Alle samengestelde slangen worden hydraulisch geperst en uitgebreid getest.
Losse slang is geprijsd per rol.







 Synthetisch Rubber,
Weer- en oliebestendig

 -40°C tot +100°C







Voor meer informatie zie technisch datablad: 807



Hydrauliek slang "non skive" SAE 100-R1-AT
(1 staaldraad inlage)

					
100R1AT-04-100	1/4"	100	17,8	225	249.35
100R1AT-06-100	3/8"	100	20,5	180	327.85
100R1AT-08-100	1/2"	100	23,4	160	392.50
100R1AT-12-50	3/4"	50	30,8	105	316.25
100R1AT-16-50	1"	50	39,1	88	446.35
100R1AT-20-40	1.1/4"	40	48,5	63	512.60
100R1AT-24-40	1.1/2"	40	57,0	50	647.40
100R1AT-32-40	2"	40	69,4	40	859.90

Hydrauliek slang "non skive" SAE 100-R2-AT
(2 staaldraad inlagen)

					
100R2AT-04-100	1/4"	100	19,0	400	318.60
100R2AT-06-100	3/8"	100	21,3	330	420.15
100R2AT-08-100	1/2"	100	24,4	275	498.65
100R2AT-12-50	3/4"	50	32,0	215	380.90
100R2AT-16-50	1"	50	40,3	165	514.80
100R2AT-20-40	1.1/4"	40	51,0	125	550.35
100R2AT-24-40	1.1/2"	40	59,8	90	695.05
100R2AT-32-40	2"	40	72,4	80	1028.25

Hydrauliek slang



Hydrauliek
Snelkoppelingen
Afsluiters
Roestvast staal
Fittingen
Luchtconditionering
Gereedschap
Vacuümtechniek
Pneumatiek
Onderdelen compressoren
Diversen
Malleabele fittingen & Staal
Ringleidingssystemen
Slangen
Water, Gas, Sanitair, Verwarming



400

Samengestelde hydrauliek slang met 2 staaldraad inlagen - SAE100R2 - 2 x 1/4" BSP female 60° conisch dichtend - draaibaar

HYSL	ID. mm	OD. mm	L. mm	€
AS106300	6.4	15	300	9.65
AS106400	6.4	15	400	10.60
AS106500	6.4	15	500	11.55
AS106600	6.4	15	600	12.50
AS106700	6.4	15	700	13.45
AS106750	6.4	15	750	13.90
AS106800	6.4	15	800	14.40
AS106900	6.4	15	900	15.35
AS1061000	6.4	15	1000	16.30
AS1061200	6.4	15	1200	18.20
AS1061500	6.4	15	1500	21.05
AS1061800	6.4	15	1800	23.90
AS1062000	6.4	15	2000	25.80



215

Samengestelde hydrauliek slang met 2 staaldraad inlagen - SAE100R2 - 2 x 3/4" BSP female 60° conisch dichtend - draaibaar

HYSL	ID. mm	OD. mm	L. mm	€
AS119300	19	29.3	300	25.25
AS119400	19	29.3	400	27.10
AS119500	19	29.3	500	28.95
AS119600	19	29.3	600	30.80
AS119700	19	29.3	700	32.65
AS119800	19	29.3	800	34.50
AS119900	19	29.3	900	36.35
AS1191000	19	29.3	1000	38.20
AS1191200	19	29.3	1200	41.90
AS1191500	19	29.3	1500	47.45
AS1191800	19	29.3	1800	53.00
AS1192000	19	29.3	2000	56.70



330

Samengestelde hydrauliek slang met 2 staaldraad inlagen - SAE100R2 - 2 x 3/8" BSP female 60° conisch dichtend - draaibaar

HYSL	ID. mm	OD. mm	L. mm	€
AS195300	9.5	19.1	300	10.60
AS195400	9.5	19.1	400	11.70
AS195500	9.5	19.1	500	12.80
AS195600	9.5	19.1	600	13.90
AS195700	9.5	19.1	700	15.00
AS195750	9.5	19.1	750	15.55
AS195800	9.5	19.1	800	16.10
AS195900	9.5	19.1	900	17.20
AS1951000	9.5	19.1	1000	18.30
AS1951200	9.5	19.1	1200	20.50
AS1951500	9.5	19.1	1500	23.80
AS1951800	9.5	19.1	1800	27.10
AS1952000	9.5	19.1	2000	29.30



165

Samengestelde hydrauliek slang met 2 staaldraad inlagen - SAE100R2 - 2 x 1" BSP female 60° conisch dichtend - draaibaar

HYSL	ID. mm	OD. mm	L. mm	€
AS125300	25.4	38.1	300	33.90
AS125400	25.4	38.1	400	36.00
AS125500	25.4	38.1	500	38.10
AS125600	25.4	38.1	600	40.20
AS125700	25.4	38.1	700	42.30
AS125800	25.4	38.1	800	44.40
AS125900	25.4	38.1	900	46.50
AS1251000	25.4	38.1	1000	48.60
AS1251200	25.4	38.1	1200	52.80
AS1251500	25.4	38.1	1500	59.10
AS1251800	25.4	38.1	1800	65.40
AS1252000	25.4	38.1	2000	69.60



275

Samengestelde hydrauliek slang met 2 staaldraad inlagen - SAE100R2 - 2 x 1/2" BSP female 60° conisch dichtend - draaibaar

HYSL	ID. mm	OD. mm	L. mm	€
AS113300	12.7	22.2	300	13.80
AS113400	12.7	22.2	400	15.05
AS113500	12.7	22.2	500	16.30
AS113600	12.7	22.2	600	17.55
AS113700	12.7	22.2	700	18.80
AS113800	12.7	22.2	800	20.05
AS113900	12.7	22.2	900	21.30
AS1131000	12.7	22.2	1000	22.55
AS1131200	12.7	22.2	1200	25.05
AS1131500	12.7	22.2	1500	28.80
AS1131800	12.7	22.2	1800	32.55
AS1132000	12.7	22.2	2000	35.05

14 Hydrauliek slang



Hydrauliek
Snel-
koppelingen
Afsluiters
Roestvast
staal

Fittingen 400

Lucht-
conditionering
Gereedschap
Vacuum-
techniek
Pneumatiek
Onderdelen
compressoren
Diversen
Malleabele
fittings
& Staal
Ringleiding-
systemen
Slangen
Water, Gas,
Sanitair,
Verwarming

Samengestelde hydrauliek slang met 2 staaldraad inlagen - SAE100R2 - 1/4" BSP female 60° conisch dichtend x 1/4" BSP female 60° conisch dichtend (bocht 90°) - draaibaar

HYSL	ID mm	OD mm	L mm	€
AS206300	6.4	15	300	12.20
AS206400	6.4	15	400	13.15
AS206500	6.4	15	500	14.10
AS206600	6.4	15	600	15.05
AS206700	6.4	15	700	16.00
AS206750	6.4	15	750	16.50
AS206800	6.4	15	800	16.95
AS206900	6.4	15	900	17.90
AS2061000	6.4	15	1000	18.85
AS2061200	6.4	15	1200	20.75
AS2061500	6.4	15	1500	23.60
AS2061800	6.4	15	1800	26.45
AS2062000	6.4	15	2000	28.35

330

Samengestelde hydrauliek slang met 2 staaldraad inlagen - SAE100R2 - 3/8" BSP female 60° conisch dichtend x 3/8" BSP female 60° conisch dichtend (bocht 90°) - draaibaar

HYSL	ID mm	OD mm	L mm	€
AS295300	9.5	19.1	300	13.15
AS295400	9.5	19.1	400	14.25
AS295500	9.5	19.1	500	15.35
AS295600	9.5	19.1	600	16.45
AS295700	9.5	19.1	700	17.55
AS295750	9.5	19.1	750	18.10
AS295800	9.5	19.1	800	18.65
AS295900	9.5	19.1	900	19.75
AS2951000	9.5	19.1	1000	20.85
AS2951200	9.5	19.1	1200	23.05
AS2951500	9.5	19.1	1500	26.35
AS2951800	9.5	19.1	1800	29.65
AS2952000	9.5	19.1	2000	31.85

275

Samengestelde hydrauliek slang met 2 staaldraad inlagen - SAE100R2 - 1/2" BSP female 60° conisch dichtend x 1/2" BSP female 60° conisch dichtend (bocht 90°) - draaibaar

HYSL	ID mm	OD mm	L mm	€
AS213300	12.7	22.2	300	15.35
AS213400	12.7	22.2	400	16.60
AS213500	12.7	22.2	500	17.85
AS213600	12.7	22.2	600	19.10
AS213700	12.7	22.2	700	20.35
AS213800	12.7	22.2	800	21.60
AS213900	12.7	22.2	900	22.85
AS2131000	12.7	22.2	1000	24.10
AS2131200	12.7	22.2	1200	26.60
AS2131500	12.7	22.2	1500	30.35
AS2131800	12.7	22.2	1800	34.10
AS2132000	12.7	22.2	2000	36.60

215

Samengestelde hydrauliek slang met 2 staaldraad inlagen - SAE100R2 - 3/4" BSP female 60° conisch dichtend x 3/4" BSP female 60° conisch dichtend (bocht 90°) - draaibaar

HYSL	ID mm	OD mm	L mm	€
AS219300	19	29.3	300	23.60
AS219400	19	29.3	400	25.45
AS219500	19	29.3	500	27.30
AS219600	19	29.3	600	29.15
AS219700	19	29.3	700	31.00
AS219800	19	29.3	800	32.85
AS219900	19	29.3	900	34.70
AS2191000	19	29.3	1000	36.55
AS2191200	19	29.3	1200	40.25
AS2191500	19	29.3	1500	45.80
AS2191800	19	29.3	1800	51.35
AS2192000	19	29.3	2000	57.65

165

Samengestelde hydrauliek slang met 2 staaldraad inlagen - SAE100R2 - 1" BSP female 60° conisch dichtend x 1" BSP female 60° conisch dichtend (bocht 90°) - draaibaar

HYSL	ID mm	OD mm	L mm	€
AS225300	25.4	38.1	300	36.10
AS225400	25.4	38.1	400	38.20
AS225500	25.4	38.1	500	40.30
AS225600	25.4	38.1	600	42.40
AS225700	25.4	38.1	700	44.50
AS225800	25.4	38.1	800	46.60
AS225900	25.4	38.1	900	48.70
AS2251000	25.4	38.1	1000	50.80
AS2251200	25.4	38.1	1200	55.00
AS2251500	25.4	38.1	1500	61.30
AS2251800	25.4	38.1	1800	67.60
AS2252000	25.4	38.1	2000	71.80

Steekkoppelingen en slangen



Argus-R6 (SAE 100R6 - EN 854 R6)



Werktemperatuur:
-40°C tot +100°C
Omgevingstemperatuur:
-40°C tot +80°C

Door de speciaal gevlochten lagen is tot 20 bar het gebruik van slangklemmen en pershulzen niet noodzakelijk wanneer deze gebruikt worden in combinatie met de steekkoppelingen.

Oliebestendig synthetisch rubber met textielinlage.

Prijzen zijn per meter. Rollengtes kunnen verschillen.

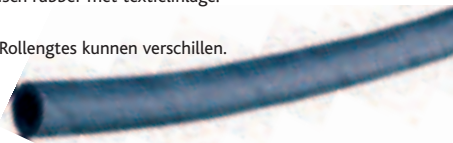

Opsteekslang van synthetisch rubber met textiel inlage



FLEX604-14	1/4"	6	12.7	28	110	64	Zwart	6.15	
FLEX606-38	3/8"	10	15.9	28	110	76	Zwart	6.60	
FLEX608-12	1/2"	13	19.8	28	110	100	Zwart	8.35	
FLEX612-34	3/4"	19	26.9	21	82	140	Zwart	12.70	
FLEX616-1	1"	25	33.4	17	68	150	Zwart	16.05	

Ook geschikt voor koelvloeistof.

Steekkoppelingen

Inschroeffkoppeling - BSP female met 60° binnenconus volgens DIN-3852-A

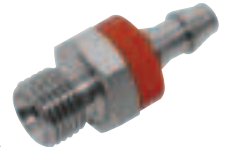

	BSPP	inch	mm	€
9220	1/4"	1/4"	6	2.40
9221	3/8"	3/8"	10	2.60
9222	1/2"	1/2"	12	3.10
9223	3/4"	3/4"	20	6.00
9224	1"	1"	25	11.20

Wartelende opschroeffkoppeling - BSP female met 60° conus



	BSPP	inch	mm	€
9240	1/4"	1/4"	6	1.90
9241	3/8"	3/8"	10	2.50
9242	1/2"	1/2"	12	3.20
9244	3/4"	3/4"	20	5.60
9245	1"	1"	25	8.85

90° gebogen wartelende opschroeffkoppeling - BSP female 60° dicht-conus



	BSPP	inch	mm	€
9280	1/4"	1/4"	6	7.00
9281	3/8"	3/8"	10	8.15
9282	1/2"	1/2"	12	9.75
9284	3/4"	3/4"	20	14.60
9285	1"	1"	25	27.85

45° gebogen wartelende opschroeffkoppeling - BSP female 60° dicht-conus



	BSPP	inch	mm	€
19280	1/4"	1/4"	6	6.90
19281	3/8"	3/8"	10	8.15
19282	1/2"	1/2"	12	9.75
19284	3/4"	3/4"	20	13.30
19285	1"	1"	25	27.85

Andere schroefdraden zoals NPT, metrisch & JIC vindt u in hoofdstuk 1

Hydrauliek
Snelkoppelingen
Afsluiters
Roestvast staal
Fittingen
Luchtconditionering
Gereedschap
Vacuümtechniek
Pneumatiek
Onderdelen compressoren
Diversen
Malleabele fittingen & Staal
Ringleidingssystemen
Slangen
Water, Gas, Sanitair, Verwarming

14 Slangpilaren kunststof serie 8300



Hydrauliek 14 Blauw Nylon 66 -20°C tot 110°C

Snelkoppelingen

Afsluiters

Roestvast staal

Fittingen

Luchtconditionering

Gereedschap

Vacuumtechniek

Pneumatiek

Onderdelen compressoren

Diversen

Malleabele fittingen & Staal

Ringleidingssystemen

Slangen

Water, Gas, Sanitair, Verwarming



Slangpilaar inschroef - kunststof met BSPT draad

KDR	To Suit Hose I.D. mm	BSPT	€
83190410	4	1/8"	0.60
83190413	4	1/4"	0.60
83190510	5	1/8"	0.60
83190513	5	1/4"	0.60
83190610	6	1/8"	0.60
83190613	6	1/4"	0.75
83190617	6	3/8"	0.70
83190621	6	1/2"	0.75
83190627	6	3/4"	0.75
83190810	8	1/8"	0.80
83190813	8	1/4"	0.90
83190817	8	3/8"	0.90
83190821	8	1/2"	0.90
83190827	8	3/4"	0.90
83191013	10	1/4"	0.95
83191017	10	3/8"	1.00
83191021	10	1/2"	1.00
83191027	10	3/4"	1.00
83191213	12	1/4"	1.00
83191217	12	3/8"	1.00
83191221	12	1/2"	1.05
83191227	12	3/4"	1.05
83191417	14	3/8"	1.05
83191421	14	1/2"	1.05
83191427	14	3/4"	1.05
83191621	16	1/2"	1.00
83191627	16	3/4"	1.30
83191921	19	1/2"	1.30
83191927	19	3/4"	1.30
83191932	19	1"	1.30
83192527	25	3/4"	1.35
83192532	25	1"	1.35



Slangpilaar inschroef - voor paneelmontage - kunststof met BSPT draad

KDR	To Suit Hose I.D. mm	BSPT	€
83201021	10	1/2"	1.30

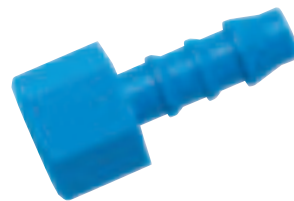

Opschroef slangpilaar - kunststof - met BSP draad

KDR	To Suit Hose I.D. mm	BSP	€
83210510	5	1/8"	0.55
83210513	5	1/4"	0.65
83211517	5	3/8"	0.65
83210521	5	1/2"	0.70
83210610	6	1/8"	0.55
83210613	6	1/4"	0.65
83211617	6	3/8"	0.65
83210621	6	1/2"	0.70
83210810	8	1/8"	0.65
83210813	8	1/4"	0.70
83210817	8	3/8"	0.75
83210821	8	1/2"	0.80
83211013	10	1/4"	0.75
83211017	10	3/8"	0.80
83211021	10	1/2"	0.80
83211213	12	1/4"	0.80
83211217	12	3/8"	0.80
83211221	12	1/2"	0.90
83211417	14	3/8"	0.80
83211421	14	1/2"	0.90
83211621	16	1/2"	0.95
83211921	19	1/2"	0.95



Wartelende opschroef slangpilaar - kunststof - met BSP draad

KDR	To Suit Hose I.D. mm	BSP	€
83330410	4	1/8"	1.50
83330413	4	1/4"	1.55
83330510	5	1/8"	1.40
83330513	5	1/4"	1.45
83330517	5	3/8"	1.50
83330613	6	1/4"	1.45
83330617	6	3/8"	1.85
83330621	6	1/2"	1.85
83330813	8	1/4"	1.50
83330817	8	3/8"	1.70
83330821	8	1/2"	2.00
83330827	8	3/4"	1.90
83331017	10	3/8"	2.00
83331021	10	1/2"	2.60
83331027	10	3/4"	2.00
83331221	12	1/2"	1.85
83331227	12	3/4"	2.20
83331421	14	1/2"	2.70
83331427	14	3/4"	3.00
83331627	16	3/4"	3.05
83331927	19	3/4"	2.25

Slangpilaren kunststof serie 8300



Knie inschroef slangpilaar - kunststof met BSPT draad

KDR	To Suit Hose I.D. mm	BSPT	€
83500410	4	1/8"	0.75
83500413	4	1/4"	0.80
83500510	5	1/8"	0.75
83500513	5	1/4"	0.80
83500521	5	1/2"	0.75
83500610	6	1/8"	0.75
83500613	6	1/4"	0.90
83500617	6	3/8"	0.95
83500621	6	1/2"	0.95
83500810	8	1/8"	1.00
83500813	8	1/4"	1.00
83500817	8	3/8"	1.00
83500821	8	1/2"	1.00
83501013	10	1/4"	1.05
83501017	10	3/8"	1.05
83501021	10	1/2"	1.20
83501027	10	3/4"	1.05
83501213	12	1/4"	1.20
83501217	12	3/8"	1.20
83501221	12	1/2"	1.30
83501227	12	3/4"	1.05
83501417	14	3/8"	1.30
83501421	14	1/2"	1.05
83501427	14	3/4"	1.00
83501621	16	1/2"	1.50
83501627	16	3/4"	1.55
83501921	19	1/2"	1.60
83501927	19	3/4"	1.65



T- inschroef slangpilaar - kunststof met BSPT draad

KDR	To Suit Hose I.D. mm	BSPT	€
83530410	4	1/8"	0.60
83530413	4	1/4"	0.70
83530510	5	1/8"	0.60
83530513	5	1/4"	0.70
83530610	6	1/8"	0.70
83530613	6	1/4"	0.75
83530617	6	3/8"	0.80
83530621	6	1/2"	0.90
83530810	8	1/8"	1.00
83530813	8	1/4"	1.05
83530817	8	3/8"	1.00
83530821	8	1/2"	1.05
83531013	10	1/4"	1.20
83531017	10	3/8"	1.20
83531021	10	1/2"	1.30
83531027	10	3/4"	1.20
83531213	12	1/4"	1.20
83531217	12	3/8"	1.20
83531221	12	1/2"	1.30
83531227	12	3/4"	1.20
83531417	14	3/8"	1.30
83531421	14	1/2"	1.45
83531427	14	3/4"	1.20
83531621	16	1/2"	1.50
83531627	16	3/4"	1.60
83531921	19	1/2"	1.65
83531927	19	3/4"	1.75



Verbindings slangpilaar - Kunststof

KDR	To Suit Hose I.D. mm	€
83310404	4	0.60
83330505	5	0.55
83310606	6	0.60
83310808	8	0.60
83311010	10	0.70
83311212	12	0.75
83311414	14	0.80
83311616	16	0.90
83311919	19	0.95

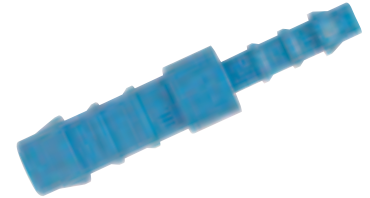

Reduceer verbinding slangpilaar - kunststof

KDR	To Suit Hose I.D. mm	€
83320504	5 - 4	0.60
83320604	6 - 4	0.60
83320605	6 - 5	0.65
83320805	8 - 5	0.65
83320806	8 - 6	0.70
83321006	10 - 6	0.75
83321008	10 - 8	0.80
83321208	12 - 8	0.90
83321210	12 - 10	0.95
83321410	14 - 10	0.95
83321412	14 - 12	1.00
83321612	16 - 12	1.05
83321614	16 - 14	1.20
83321914	19 - 14	1.20
83321916	19 - 16	1.20



Knie slangpilaar - kunststof

KDR	To Suit Hose I.D. mm	€
83340400	4	0.55
83340500	5	0.65
83340600	6	0.65
83340800	8	0.70
83341000	10	0.80
83341200	12	0.80
83341400	14	0.95
83341600	16	1.00
83341900	19	1.10

Hydrauliek
Snelkoppelingen
Afsluiters
Roestvast staal
Fittingen
Luchtconditionering
Gereedschap
Vacuümtechniek
Pneumatiek
Onderdelen compressoren
Diversen
Malleabele fittingen & Staal
Ringleidingssystemen
Slangen
Water, Gas, Sanitair, Verwarming

14 Slangpilaren kunststof serie 8300



Hydrauliek
Snel-
koppelingen
Afsluiters
Roestvast
staal

Fittingen Knie verloop slangpilaar - kunststof



	KDR	To Suit Hose I.D. mm	€
Lucht- conditionering			
	83350504	5 - 4	0.65
	83350605	6 - 5	0.65
Gereedschap	83350806	8 - 6	0.70
	83351006	10 - 6	0.75
Vacuum- techniek	83351008	10 - 8	0.75
	83351210	12 - 10	0.80
Pneumatiek	83351412	14 - 12	0.95
	83351614	16 - 14	0.95
	83351916	19 - 16	1.00

Onderdelen
compressoren

Diversen

Malleabele
fittingen
& Staal

Ringleiding-
systemen

Slangen

Water, Gas,
Sanitair,
Verwarming

Y-slangpilaar - kunststof

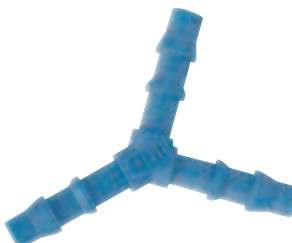

	KDR	To Suit Hose I.D. mm	€
	83570400	4	0.65
	83570600	6	0.75
	83570800	8	1.00
	83571000	10	1.35
	83571700	17	1.60

T- verloop slangpilaar - kunststof

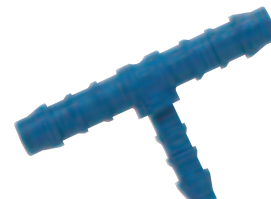

	KDR	To Suit Hose I.D. mm	€
	83550504	5 - 4	0.75
	83550605	6 - 5	0.80
	83550806	8 - 6	1.00
	83551008	10 - 8	1.00
	83551210	12 - 10	1.05
	83551412	14 - 12	1.20
	83551614	16 - 14	1.60
	83551916	19 - 16	1.70

T- slangpilaar - kunststof

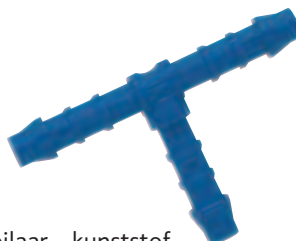

	KDR	To Suit Hose I.D. mm	€
	83540400	4	0.60
	83540500	5	0.70
	83540600	6	0.90
	83540800	8	1.00
	83541000	10	1.05
	83541200	12	1.20
	83541400	14	1.20
	83541600	16	1.35
	83541900	19	1.60

Slangpilaren



Slangpilaren serie 4000



Max. druk bij 20°C:

1/8" = 150 bar 1/2" = 50 bar
 1/4" = 100 bar 3/4" = 85 bar
 3/8" = 75 bar 1" = 80 bar

Veiligheidsfactor 4



Messing vernikkeld MS-58, UNI-5705 stroomloos vernikkeld in- en uitwendig.



Slangpilaar opschroef - messing vernikkeld, met BSP draad



DRAA	To Suit Hose I.D. mm	BSPP	mm	C	€
40200610	6	1/8"	19	14	1.30
40200710	7	1/8"	19	14	1.30
40200713	7	1/4"	19	17	1.35
40200813	8	1/4"	19	17	1.50
40200913	9	1/4"	19	17	1.50
40200917	9	3/8"	19	20	1.95
40201017	10	3/8"	19	20	1.95
40201217	12	3/8"	20	20	1.95
40201221	12	1/2"	20	24	2.70



Slangpilaar inschroef - messing vernikkeld, met BSP draad



DRAA	To Suit Hose I.D. mm	BSPP	mm	C	€
40390710	7	1/8"	20	14	1.00
40390713	7	1/4"	20	17	1.30
40390810	8	1/8"	20	14	1.10
40390910	9	1/8"	20	14	1.10
40390913	9	1/4"	20	17	1.35
40390917	9	3/8"	20	19	1.70
40391213	12	1/4"	20	17	1.35
40391217	12	3/8"	20	19	1.70
40391221	12	1/2"	22	24	2.55
40391717	17	3/8"	24	19	1.85
40391721	17	1/2"	24	24	2.70



Slangpilaar inschroef - messing vernikkeld, met BSPT draad



DRAA	To Suit Hose I.D. mm	BSPT	mm	C	€
40190405	4	M5	15	8	0.70
40190610	6	1/8"	20	12	0.95
40190613	6	1/4"	20	14	1.10
40190710	7	1/8"	20	12	0.95
40190713	7	1/4"	20	14	1.10
40190810	8	1/8"	20	12	1.00
40190813	8	1/4"	20	14	1.15
40190910	9	1/8"	20	12	1.00
40190913	9	1/4"	20	14	1.20
40190917	9	3/8"	20	17	1.70
40190921	9	1/2"	20	22	2.10
40191010	10	1/8"	20	12	1.15

Slangpilaar inschroef, messing vernikkeld, met BSPT draad (vervolg)



DRAA	To Suit Hose I.D. mm	BSPT	mm	C	€
40191013	10	1/4"	20	14	1.20
40191017	10	3/8"	20	17	1.70
40191021	10	1/2"	20	22	2.15
40191213	12	1/4"	20	14	1.20
40191217	12	3/8"	20	17	1.70
40191221	12	1/2"	20	22	2.15
40191417	14	3/8"	20	17	1.95
40191421	14	1/2"	20	22	2.25
40191617	16	3/8"	20	17	2.10
40191621	16	1/2"	20	22	2.45
40191627	16	3/4"	20	27	3.55
40191717	17	3/8"	20	19	2.15
40191721	17	1/2"	20	22	2.55
40191817	18	3/8"	20	19	2.60
40191821	18	1/2"	20	22	2.70
40191827	18	3/4"	20	27	3.70
40192017	20	3/8"	20	21	2.50
40192021	20	1/2"	20	22	2.55
40192027	20	3/4"	20	27	3.20
40192527	25	3/4"	20	27	3.55
40192532	25	1"	30	34	5.65

Hydrauliek
 Snelkoppelingen
 Afsluiters
 Roestvast staal
 Fittingen
 Luchtconditionering
 Gereedschap
 Vacuümtechniek
 Pneumatiek
 Onderdelen compressoren
 Diversen
 Malleabele fittingen & Staal
 Ringleidingssystemen
 Slangen
 Water, Gas, Sanitair, Verwarming

14 Slangpilaren



Hydrauliek

Snelkoppelingen

Afsluiters

Roestvast staal

Fittingen

Luchtconditionering

Gereedschap

Vacuumtechniek

Pneumatiek

Onderdelen compressoren

Diversen

Malleabele fittingen & Staal

Ringleidingssystemen

Slangen

Water, Gas, Sanitair, Verwarming

Verbindings slangpilaar van vernikkeld staal



DRAA	To Suit Hose I.D. mm	€
40310707	7	1.60
40310909S	9	1.70
40311111	11	2.30

Slangpilaar inschroef - draaibaar - (staal vernikkeld) - met BSPT draad



DRAA	To Suit Hose I.D. mm	BSPT	€
40400713	7	1/4"	15 4.40
40400717	7	3/8"	15 5.10
40400917	9	3/8"	15 5.30
40401113	11	1/4"	15 4.40
40401117	11	3/8"	15 5.30
40401417	14	3/8"	17 5.10

Slangpilaar mini

Als montage van slangen efficiënter, kleiner en sneller moet zijn, worden deze mini slangpilaren toegepast.

Zeer geschikt voor besturingspanelen, logische besturing en minipneumatiek.

Draad: metrisch volgens ISO R/262.

Slang: te gebruiken met PE, PA, PU, PPC, HYTEL, PTTE, en VINNYLAN.

De slang wordt door de vorm van de pilaar direct vastgehouden. SLANGKLEMMEN ZIJN OVERBODIG.

De sterkte van de bevestiging is afhankelijk van de tolerantie en kwaliteit van de toegepaste slang.

Bij demontage dient de slang in de lengte van de pilaar te worden losgesneden.



1 tot 10



-10°C tot 80°C



Inschroef - metrisch - speed

DRAA	To Suit Hose I.D. mm	M	€
41190305	3	M5	0.95
41190405	4	M5	0.95

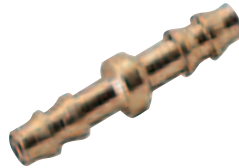

Verbinding - gelijk & verlopend - speed

DRAA	To Suit Hose I.D. mm	€
41310202	2 x 2	1.30
41310302	3 x 2	1.30
41310303	3 x 3	1.30
41310403	4 x 3	1.40
41310404	4 x 4	1.40
41310604	6 x 4	1.40
41310606	6 x 6	1.40

Knie

DRAA	To Suit Hose I.D. mm	€
41020202	2	2.35
41020303	3	2.35
41020404	4	2.60
41020606	6	2.60



Tee

DRAA	To Suit Hose I.D. mm	€
41030202	2	2.90
41030303	3	2.90
41030404	4	3.05
41030606	6	3.05



Slangpilaren



14

Roestvaststalen slangpilaren AISI-316

Hoogwaardige industriële kwaliteit.

Normering: BSPT-Conische schroefdraad, BS21;ISO 7.1; DIN-2999,
BSP-Parallel schroefdraad, BS2779;ISO 228.

Veiligheidsfactor: 4



AISI-316 (1.4404) = Cr 16-18%, Ni 10-14%, Mn 2% max, Mo 2-3% max, Si 1% max, C 0,08% max, 0.045%max, S0.0. 3%max.



RVS-AISI-316 slangpilaar inschroef BSPT male

	To Suit Hose I.D. mm		
HT-18	4	1/8"	3.55
HT-18-6	6	1/8"	3.55
HT-14	6	1/4"	4.20
HT-14-08	8	1/4"	4.15
HT-14-10	10	1/4"	4.50
HT-14-13	13	1/4"	4.40
HT-38-08	8	3/8"	5.50
HT-38	10	3/8"	5.50
HT-38-13	13	3/8"	6.00
HT-12-06	6	1/2"	9.30
HT-12-10	10	1/2"	9.30
HT-12	13	1/2"	9.95
HT-12-19	19	1/2"	10.30
HT-12-25	25	1/2"	14.15
HT-34-13	13	3/4"	12.60
HT-34	19	3/4"	14.40
HT-1-19	19	1"	25.25
HT-1	25	1"	19.20
HT-1-31	31	1"	22.75
HT-114	31	1.1/4"	14.15
HT-112	38	1.1/2"	21.40
HT-2	50	2"	32.80
HT-212	63	2.1/2"	49.05
HT-3	75	3"	61.45
HT-4	100	4"	126.80

RVS-AISI-316 slangpilaar opschroef BSP female

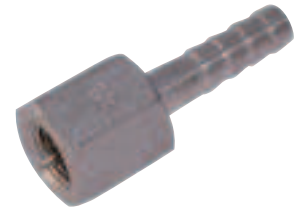

	To Suit Hose I.D. mm		
SFHT10/06	6	1/8"	7.60
SFHT13/06	6	1/4"	8.90
SFHT13/09	9	1/4"	8.90
SFHT17/10	10	3/8"	10.80
SFHT21/13	13	1/2"	14.00
SFHT26/19	19	3/4"	17.10
SFHT33/25	25	1"	19.50
SFHT42/32	32	1 1/4"	27.30
SFHT48/38	38	1 1/2"	43.40
SFHT52/51	51	2"	55.00

Hydrauliek
Snelkoppelingen
Afsluiters
Roestvast staal
Fittingen
Luchtconditionering
Gereedschap
Vacuümtechniek
Pneumatiek
Onderdelen compressoren
Diversen
Malleabele fittingen & Staal
Ringleidingssystemen
Slangen
Water, Gas, Sanitair, Verwarming

14 Slangpilaren



Hydrauliek

Snelkoppelingen

Afsluiters

Roestvast staal RVS-AISI-316 wartelende opschroef slangpilaar 60° bolconus BSP female

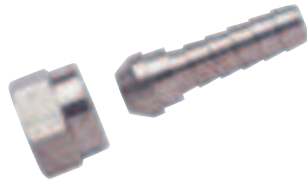

Fittingen	RVSK	To Suit Hose I.D. mm	BSPP	€
Luchtconditionering				
FH13/14SS		6	1/4"	5.00
FH17/38SS		10	3/8"	7.80
FH21/12SS		13	1/2"	10.60
Gereedschap				
FH26/34SS		19	3/4"	15.10

Vacuumtechniek

Pneumatiek

Onderdelen compressoren

Diversen RVS-AISI-316 verbindings slangpilaar



Malleabele fittingen & Staal	RVSK	To Suit Hose I.D. mm	€
Ringleidingssystemen			
DS06-SS		6	3.65
DS08-SS		8	4.00
DS10-SS		10	4.25
Slangen			
DS13-SS		13	4.85

Water, Gas, Sanitair, Verwarming

Slangpilaar inschroef, roestvast staal met BSPT schroefdraad



RVSK	BSPT	€
SCN-12	1/2"	19.15
SCN-34	3/4"	19.30
SCN-1	1"	21.80
SCN-114	1.1/4"	26.35
SCN-112	1.1/2"	33.15
SCN-2	2"	39.15
SCN-212	2.1/2"	88.70
SCN-3	3"	102.20



tot 140 bar tot 225°C

HIGH PRESSURE

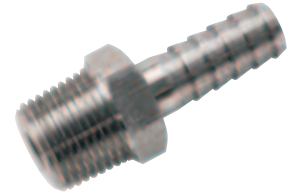

RVS-AISI-316L hogedruk slangpilaar inschroef met BSPT buitendraad - dikwandig gedraaid

RVSK	To Suit Hose I.D. mm	BSPT	mm	H mm	€
60190610	6	1/8"	19.5	11	6.75
60190710	7	1/8"	19.5	11	6.80
60190713	7	1/4"	19.5	14	8.30
60190813	8	1/4"	19.5	14	8.20
60190913	9	1/4"	19.5	14	8.30
60190917	9	3/8"	19.5	17	10.70
60191013	10	1/4"	19.5	14	8.20
60191017	10	3/8"	19.5	17	10.70
60191021	10	1/2"	19.5	22	12.50
60191213	12	1/4"	19.5	14	15.90
60191217	12	3/8"	19.5	17	9.45
60191221	12	1/2"	19.5	22	15.90
60191417	14	3/8"	19.5	17	10.50
60191421	14	1/2"	19.5	22	15.90
60191621	16	1/2"	19.5	22	16.05
60191821	18	1/2"	19.5	22	16.25
60191827	18	3/4"	19.5	27	22.85
60192021	20	1/2"	19.5	22	16.80
60192027	20	3/4"	19.5	27	22.85

Slangpilaren



Messing slangpilaren

Schroefdraad: ISO 7.1, BS 21, DIN-2999.
 Parallel: ISO 228, klasse A.
 Toepassing: algemeen
 Gebruik: brandstof, gas, olie, perslucht, hydraulica, water enz.
 Bestendigheid: standaard, niet geschikt voor: ammoniak, zuren, chloor ed.
 Veiligheidsfactor: 3

De opgegeven werkdruk is gebaseerd op een temperatuur van 20°C. Iedere temperatuurverhoging boven 20°C heeft effect op de druk/vacuüm bestendigheid.

Automaten messing MS-58

Indicatie: -20°C tot +400°C

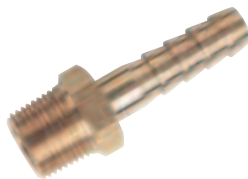

Slangpilaar inschroef, blank messing, met BSPT draad

DRAM	To Suit Hose I.D. mm	BSPT	bar	€
GT10/04K	4	1/8"	200	1.15
GT10/05K	5	1/8"	200	1.15
GT10/06K	6	1/8"	200	0.95
GT10/08K	8	1/8"	200	1.40
GT10/09K	9	1/8"	200	1.40
GT13/04K	4	1/4"	150	1.70
GT13/05K	5	1/4"	150	1.50
GT13/06K	6	1/4"	150	0.95
GT13/08K	8	1/4"	150	1.15
GT13/09K	9	1/4"	150	1.20
GT13/13K	13	1/4"	150	1.70
GT17/06K	6	3/8"	100	2.10
GT17/08K	8	3/8"	100	1.85
GT17/09K	9	3/8"	100	2.10
GT17/13K	13	3/8"	100	2.15
GT17/16K	16	3/8"	100	2.85
GT17/19K	19	3/8"	100	5.15
GT21/06K	6	1/2"	100	2.30
GT21/09K	9	1/2"	100	2.50
GT21/13K	13	1/2"	100	3.00
GT21/19K	19	1/2"	100	3.60
GT21/25K	25	1/2"	100	7.50
GT26/09K	9	3/4"	100	4.10
GT26/13K	13	3/4"	100	3.85
GT26/16K	16	3/4"	100	4.70
GT26/19K	19	3/4"	100	4.45
GT26/25K	25	3/4"	100	6.50
GT33/13K	13	1"	100	7.40
GT33/19K	19	1"	100	7.15
GT33/25K	25	1"	100	7.55
GT33/31K	31	1"	100	9.10
GT42/25K	25	1.1/4"	100	11.45
GT42/31K	31	1.1/4"	100	14.00
GT48/38K	38	1.1/2"	100	21.20
GT52/50K	50	2"	100	27.90

Tee-slangpilaar, blank messing



DRAM	To Suit Hose I.D. mm	bar	€
THT-5	5	100	3.50
THT-6	6	100	3.50
THT-8	8	100	2.35
THT-10	10	50	3.35
THT-13	13	50	5.50

Knie inschroef slangpilaar, blank messing x BSPT



DRAM	To Suit Hose I.D. mm	BSPT	bar	€
EHT-18-6	6	1/8"	100	3.20
EHT-18-8	8	1/8"	100	3.20
EHT-18-10	10	1/8"	100	3.20
EHT-14-6	6	1/4"	100	3.35
EHT-14-8	8	1/4"	100	3.20
EHT-14-10	10	1/4"	100	3.20
EHT-14-13	13	1/4"	100	7.25
EHT-38-6	6	3/8"	100	4.20
EHT-38-8	8	3/8"	100	4.20
EHT-38-10	10	3/8"	100	3.90
EHT-38-13	13	3/8"	100	6.60
EHT-12-8	8	1/2"	100	7.25
EHT-12-10	10	1/2"	100	7.65
EHT-12-13	13	1/2"	100	7.70

Verbindings slangpilaar van messing

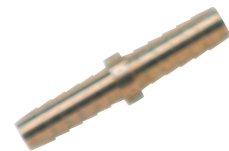

DRAM	To Suit Hose I.D. mm	€
40310505	5	1.20
40310606	6	1.15
40310808	8	1.40
40310909	9	1.55
40311313	13	1.80
40311616	16	2.15
40311919	19	3.10
40312525	25	7.05

Hydrauliek
 Snelkoppelingen
 Afsluiters
 Roestvast staal
 Fittingen
 Luchtconditionering
 Gereedschap
 Vacuümtechniek
 Pneumatiek
 Onderdelen compressoren
 Diversen
 Malleabele fittingen & Staal
 Ringleidingssystemen
 Slangen
 Water, Gas, Sanitair, Verwarming

14 Slangpilaren



Hydrauliek

Snelkoppelingen

Afsluiters

Roestvast staal

Fittingen

Y-slangpilaar in blank messing

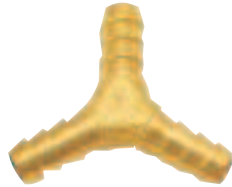

To Suit Hose I.D.



Luchtconditionering	To Suit Hose I.D.	Price	
2020-1943	1/4" (6,5mm)	4.35	
2020-1950	5/16" (9mm)	4.80	
2020-1968	3/8" (11mm)	6.30	
Gereedschap	2020-1976	1/2" (14mm)	10.85

Vacuumtechniek

Pneumatiek

Onderdelen compressoren

Diversen

Wartelende slangpilaar, opschroef met 60° bolconus x female BSP

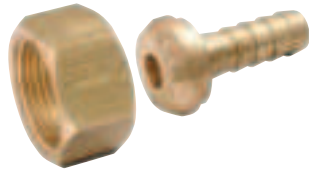

To Suit Hose I.D. mm



Malleabele fittingen & Staal	To Suit Hose I.D. mm	BSPP	Bar	Price	
Ringleidingssystemen	FH10/18	4	1/8"	100	1.00
	FH13/14	6	1/4"	100	1.80
	FH13/516	8	1/4"	100	1.80
Slangen	FH13/38	10	1/4"	100	1.90
	FH17/14	6	3/8"	75	2.35
	FH17/516	8	3/8"	75	2.50
Water, Gas, Sanitair, Verwarming	FH17/38	10	3/8"	75	2.60
	FH17/12	13	3/8"	75	2.05
	FH21/38	10	1/2"	75	3.00
	FH21/12	13	1/2"	75	3.10
	FH26/34	19	3/4"	75	5.20
	FH33/1	25	1"	70	7.10

Wartelende slangpilaar, opschroef met vlakke dichting & dichtingsring x female BSP

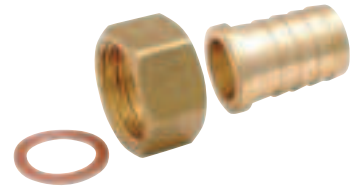

To Suit Hose I.D. mm



Product	To Suit Hose I.D. mm	BSPP	Bar	Price
FH13/316FF	5	1/4"	40	1.10
FH13/14FF	6	1/4"	40	1.20
FH13/516FF	8	1/4"	40	1.30
FH13/38FF	10	1/4"	40	1.55
FH17/14FF	6	3/8"	40	1.70
FH17/38FF	10	3/8"	40	2.05
FH17/12FF	13	3/8"	40	2.05
FH21/38FF	10	1/2"	40	2.25
FH21/12FF	13	1/2"	40	3.65
FH26/34FF	19	3/4"	40	5.40
FH33/1FF	25	1"	30	8.35

Slangpilaar inschroef, vernikkeld staal met BSPT schroefdraad



To Suit Hose I.D. mm



Product	To Suit Hose I.D. mm	BSPT	Price
CNS-12	13	1/2"	2.40
CNS-34	19	3/4"	2.60
CNS-1	25	1"	3.90
CNS-114	32	1.1/4"	4.70
CNS-112	38	1.1/2"	6.05
CNS-2	50	2"	8.85
CNS-212	62	2.1/2"	11.55
CNS-3	76	3"	14.90
CNS-4	100	4"	25.40
CNS-5	126	5"	61.80
CNS-6	150	6"	72.60

Verbindings slangpilaar van vernikkeld staal



To Suit Hose I.D. mm



Product	To Suit Hose I.D. mm	Price
SHM-12	13	2.20
SHM-34	19	2.90
SHM-1	25	3.90
SHM-114	32	3.90
SHM-112	38	4.95
SHM-2	50	11.00
SHM-212	62	12.30
SHM-3	76	17.70
SHM-4	100	27.75
SHM-5	126	69.55
SHM-6	150	139.30

Slangpilaren



NORMA 14



Nylon 6



-40°C – 90°C



1 – 10



Rechte inschroef slangpilaar

NORM	BSPT	ID. mm	€
GES4R18	1/8"	4	0.65
GES4R14	1/4"	4	0.95
GES5R14	1/4"	5	2.05
GES6R18	1/8"	6	0.90
GES6R14	1/4"	6	0.95
GES6R38	3/8"	6	1.20
GES8R18	1/8"	8	1.10
GES8R14	1/4"	8	1.10
GES8R38	3/8"	8	1.25
GES8R12	1/2"	8	1.80
GES10R14	1/4"	10	1.15
GES10R38	3/8"	10	1.25
GES12R38	3/8"	12	1.30
GES12R12	1/2"	12	1.80
GES14R38	3/8"	14	1.60
GES14R12	1/2"	14	1.95
GES16R12	1/2"	16	2.35
GES16R34	3/4"	16	2.35
GES19R34	3/4"	19	2.70
GES25R1	1"	25	3.00



Inschroefdop

NORM	BSPT	€
BSTR18	1/8"	0.45
BSTR14	1/4"	0.55
BSTR38	3/8"	1.00
BSTR12	1/2"	1.45



T- inschroef slangpilaar

NORM	BSPT	ID. mm	€
TES4R18	1/8"	4	0.90
TES4R14	1/4"	4	1.10
TES6R18	1/8"	6	1.00
TES6R14	1/4"	6	1.15
TES8R14	1/4"	8	1.40
TES10R38	3/8"	10	1.90



Haakse inschroef slangpilaar

NORM	BSPT	ID. mm	€
WES4R18	1/8"	4	0.80
WES4R14	1/4"	4	1.00
WES6R18	1/8"	6	0.95
WES6R14	1/4"	6	1.10
WES6R38	3/8"	6	1.30
WES8R18	1/8"	8	1.30
WES8R14	1/4"	8	1.30
WES8R38	3/8"	8	1.45
WES8R12	1/2"	8	2.30
WES10R14	1/4"	10	1.60
WES10R38	3/8"	10	1.70
WES12R38	3/8"	12	1.90
WES12R12	1/2"	12	2.25
WES19R34	3/4"	19	2.70
WES25R1	1"	25	3.70

Hydrauliek

Snelkoppelingen

Afsluiters

Roestvast staal

Fittingen

Luchtconditionering

Gereedschap

Vacuümtechniek

Pneumatiek

Onderdelen compressoren

Diversen

Malleabele fittingen & Staal

Ringleidingssystemen

Slangen

Water, Gas, Sanitair, Verwarming

14 Slangpilaren



Hydrauliek POM -40°C – 80°C 1 – 10

Snelkoppelingen

Afsluiters

Roestvast staal

Fittingen

Rechte slangpilaar - straight push-on



NOR-GS3	3		0.30
NOR-GS4	4		0.30
NOR-GS5	5		0.45
NOR-GS6	6		0.60
NOR-GS8	8		0.85
NOR-GS10	10		1.00
NOR-GS12	12		1.35
NOR-GS13	13		1.40
NOR-GS14	14		1.70
NOR-GS16	16		1.95
NOR-GS19	19		2.30
NOR-GS25	25		3.70

Malleabele fittingen & Staal

Ringleidingssystemen

Rechte reductieslangpilaar - reducing straight push-on



GRS4-3	4-3		0.60
GRS6-4	6-4		0.65
GRS8-4	8-4		0.90
GRS8-6	8-6		1.10
GRS10-6	10-6		1.25
GRS10-8	10-8		1.30
GRS12-8	12-8		1.45
GRS12-10	12-10		1.45

Water, Gas, Sanitair, Verwarming

T-slangpilaar - equal push-on



NOR-TS3	3		0.50
NOR-TS4	4		0.60
NOR-TS5	5		0.80
NOR-TS6	6		0.90
NOR-TS7	7		1.05
NOR-TS8	8		1.20
NOR-TS10	10		1.50
NOR-TS12	12		1.80
NOR-TS13	13		2.25
NOR-TS14	14		2.25
NOR-TS15	15		2.60
NOR-TS16	16		3.00
NOR-TS19	19		3.35
NOR-TS25	25		4.60

T-reductieslangpilaar - push-on



TRS3-4-3	3-4-3		0.90
TRS4-6-4	4-6-4		0.90
TRS6-4-6	6-4-6		0.90
TRS8-4-8	8-4-8		1.20
TRS8-6-8	8-6-8		1.20
TRS10-6-10	10-6-10		1.50
TRS10-8-10	10-8-10		1.60
TRS10-13-10	10-13-10		1.80
TRS12-6-12	12-6-12		1.90
TRS12-8-12	12-8-12		1.90
TRS12-10-12	12-10-12		2.70
TRS15-6-15	15-6-15		2.70
TRS15-8-15	15-8-15		2.70
TRS18-10-18	18-10-18		3.70
TRS18-15-18	18-15-18		3.70

Slangpilaren



Haakse-slangpilaar - push-on

NORM	ID (mm)	€
NOR-WS3	3	0.65
NOR-WS4	4	0.75
NOR-WS5	5	0.80
NOR-WS6	6	0.90
NOR-WS8	8	1.20
NOR-WS10	10	1.50
NOR-WS12	12	1.80
NOR-WS13	13	1.90
NOR-WS14	14	2.20
NOR-WS15	15	2.55
NOR-WS16	16	2.70
NOR-WS19	19	3.30
NOR-WS25	25	3.70



Y-slangpilaar - push-on

NORM	ID (mm)	€
NOR-YS3	3	0.65
NOR-YS4	4	0.65
NOR-YS5	5	0.80
NOR-YS6	6	0.90
NOR-YS8	8	1.30
NOR-YS10	10	1.50
NOR-YS12	12	1.85
NOR-YS13	13	2.05
NOR-YS14	14	2.25
NOR-YS16	16	3.00
NOR-YS19	19	3.25



Y-reduktieslangpilaar - push-on

NORM	ID (mm)	€
YRS4-6-4	6-4	0.90
YRS6-8-6	8-6	1.20

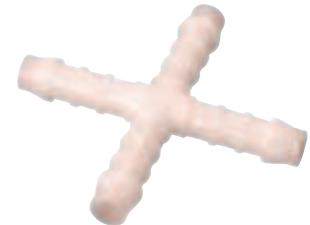

Kruis-slangpilaar - push-on

NORM	ID (mm)	€
NOR-KS4	4	1.00
NOR-KS5	5	1.20
NOR-KS6	6	1.35
NOR-KS12	12	2.95

Hydrauliek
Snelkoppelingen
Afsluiters
Roestvast staal
Fittingen
Luchtconditionering
Gereedschap
Vacuümtechniek
Pneumatiek
Onderdelen compressoren
Diversen
Malleabele fittingen & Staal
Ringleidingssystemen
Slangen
Water, Gas, Sanitair, Verwarming

14 Lube-Cool systemen 1/4" & 1/2"



De Lube-Cool systemen zijn gemaakt in Groot-Brittannië en vervaardigd van Dupont polymeer. Bestand tegen de meeste koelmiddelen, chemicaliën en aardolieproducten. Het systeem is ontworpen met het oog op eenvoudige installatie, maximale flexibiliteit en handmatige instelling. Het Lub-Cool systeem blijft staan in de ingestelde positie.

- Hydrauliek
- Snelkoppelingen
- Afsluiters
- Roestvast staal
- Fittingen
- Luchtconditionering
- Gereedschap
- Vacuumtechniek
- Pneumatiek
- Onderdelen compressoren
- Diversen
- Malleabele fittingen & Staal
- Ringleidingssystemen
- Slangen
- Water, Gas, Sanitair, Verwarming



Verbindingsstuk

	Maat	€
BH14-1	1/4"	0.85
BH12-1	1/2"	1.20

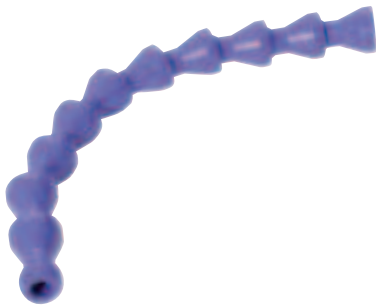

Verbindingsset - 10 x

	Maat	€
BH14-10	1/4"	8.65
BH12-10	1/2"	12.20



Ronde nozzel

	Nozzle	Maat	€
BH14-RJ1	1/16"	1/4"	0.85
BH14-RJ2	1/8"	1/4"	0.85
BH14-RJ3	3/16"	1/4"	0.85
BH14-RJ4	1/4"	1/4"	0.85
BH12-RJ1	3/8"	1/4"	2.95
BH12-RJ2	1/2"	1/4"	3.10



Eindstuk met BSP draad

		Maat	€
BH14-HC1	1/8"	1/4"	0.95
BH14-HC2	1/4"	1/4"	0.95
BH12-HC1	3/8"	1/2"	1.35
BH12-HC2	1/2"	1/2"	1.35



Regelafsluiters

	Maat	€
BH14-CV	1/4"	7.25



Y stuk

	Maat	€
BH14-YJ	1/4"	2.70
BH12-YJ	1/2"	3.50



Y verloop stuk 1/2" - 1/4"

	€
BH12-YR	3.50



Lube-Cool systemen 1/4" & 1/2"



AIR-PRO

14



Verloop 1/2" - 1/4"



BH12-RM 1.85

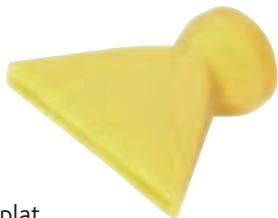

Spuitstuk - plat



	Nozzle Width	Maat	€
BH14-FJ2	1.1/4"	1/4"	1.60
BH12-FJ2	2.1/4"	1/2"	3.30
BH12-FJ1	1.3/4"	1/2"	3.10



Spuitstuk - ring



	Maat	€
BH14-RJM	1/4"	1.25
BH12-RJM	1/2"	1.25

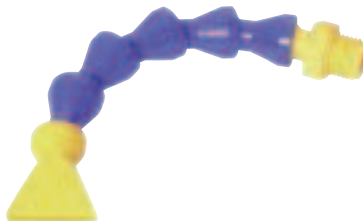

Samengestelde set met plat spuitstuk



	L mm	Maat	€
BH14-FJA1	150	1/4"	6.90
BH14-FJA2	200	1/4"	9.95
BH14-FJA3	250	1/4"	12.95
BH14-FJA4	300	1/4"	15.95
BH14-FJA5	350	1/4"	18.20
BH12-FJA1	200	1/2"	13.60
BH12-FJA2	300	1/2"	18.30
BH12-FJA3	400	1/2"	26.10

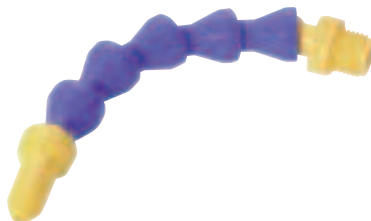

Samengestelde set met rond spuitstuk



	L mm	Maat	€
BH14-RJA1	150	1/4"	6.90
BH14-RJA2	200	1/4"	10.55
BH14-RJA3	250	1/4"	13.85
BH14-RJA4	300	1/4"	17.00
BH14-RJA5	350	1/4"	19.50
BH12-RJA1	200	1/2"	12.65
BH12-RJA2	300	1/2"	18.20
BH12-RJA3	400	1/2"	25.65

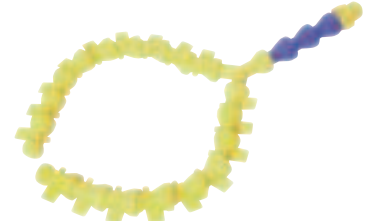

Samengestelde set met ring spuitstuk



	Maat	€
BH14-CJA	1/4"	23.85
BH12-CJA	1/2"	29.85



Ring plug



	Maat	€
BH14-RJP	1/4"	1.25
BH12-RJP	1/2"	1.25



Montage gereedschap



	Maat	€
CL14-T	1/4"	31.85
CL12-T	1/2"	36.85

Hydrauliek
Snelkoppelingen
Afsluiters
Roestvast staal
Fittingen
Luchtconditionering
Gereedschap
Vacuümtechniek
Pneumatiek
Onderdelen compressoren
Diversen
Malleabele fittingen & Staal
Ringleidingssystemen
Slangen
Water, Gas, Sanitair, Verwarming

14 Slangklemmen



Hydrauliek Milieuvriendelijk: Supra slangklemmen zijn geproduceerd volgens EU richtlijn 2002/95/EC van 1 juli 2006.
Veiligheid: De afgeschuinde hoeken van de slangklemband voorkomen schade aan de slang, en kunnen zo gevaarlijke situaties voorkomen.

Snelkoppelingen **Mikalor Super & Supra wormschroefklemmen**

Afsluiters Geel verzinkt en verchroomd

Roestvast staal

Fittingen

Luchtconditionering

Gereedschap

Vacuumtechniek

Pneumatiek

Onderdelen compressoren

Diversen

Malleabele fittingen & Staal

Ringleidingssystemen

Slangen

Water, Gas, Sanitair, Verwarming



Super W1 - zacht staal - stalen schroef

	0108	UL-2 SPAN BEREIK	€
SBC1719	17-19		0.50
SBC2022	20-22		0.55
SBC2325	23-25		0.55
SBC2628	26-28		0.55
SBC2931	29-31		0.65
SBC3235	32-35		0.70
SBC3639	36-39		0.75
SBC4043	40-43		0.80
SBC4447	44-47		1.10
SBC4851	48-51		1.10
SBC5255	52-55		1.15
SBC5659	56-59		1.20
SBC6063	60-63		1.25
SBC6467	64-67		1.25
SBC6873	68-73		1.55
SBC7479	74-79		1.60
SBC8085	80-85		1.70
SBC8691	86-91		1.70
SBC9297	92-97		1.75
SBC98103	98-103		1.80
SBC104112	104-112		1.90
SBC113121	113-121		2.00
SBC122130	122-130		2.10
SBC131139	131-139		2.85
SBC140148	140-148		2.85
SBC149161	149-161		3.30
SBC162174	162-174		3.75
SBC175187	175-187		3.55
SBC188200	188-200		3.85
SBC201213	201-213		4.00
SBC214226	214-226		4.15
SBC227239	227-239		4.10
SBC240252	240-252		4.55

Supra W2 - RVS AISI-430 - stalen schroef

	5555	UL-2 SPAN BEREIK	€
MS1901	17-19		1.10
MS1902	19-21		1.10
MS1903	21-23		1.10
MS1904	23-25		1.10
MS1905	25-27		1.15
MS1906	27-29		1.15
MS1907	29-31		1.35
MS1908	31-34		1.40
MS1909	34-37		1.50
MS1910	37-40		1.50
MS1911	40-43		1.50
MS1912	43-47		1.90
MS1913	47-51		2.00
MS1914	51-55		2.00
MS1915	55-59		2.10
MS1916	59-63		2.10
MS1917	63-68		2.15
MS1918	68-73		2.85
MS1919	73-79		2.90
MS1920	79-85		3.00
MS1921	85-91		3.05
MS1922	91-97		3.15
MS1923	97-104		3.20
MS1924	104-112		3.40
MS1925	112-121		3.50
MS1926	121-130		3.60
MS1927	130-140		5.00
MS1928	140-150		5.10
MS1929	150-162		4.25
MS1930	162-174		5.40
MS1931	174-187		5.55
MS1932	187-200		5.65
MS1933	200-213		5.80
MS1934	213-226		5.95
MS1935	226-239		6.05
MS1936	239-252		6.20

Supra W4 - RVS AISI-304 - RVS schroef

	0108	UL-2 SPAN BEREIK	€
SS1301	17-19		2.80
SS1302	19-21		2.80
SS1303	21-23		2.85
SS1304	23-25		2.90
SS1305	25-27		2.90
SS1306	27-29		3.00
SS1307	29-31		3.55
SS1308	31-34		3.60
SS1309	34-37		3.70
SS1310	37-40		3.75
SS1311	40-43		3.80
SS1312	43-47		4.75
SS1313	47-51		4.80
SS1314	51-55		4.90
SS1315	55-59		5.00
SS1316	59-63		5.05
SS1317	63-68		5.10
SS1318	68-73		7.15
SS1319	73-79		7.45
SS1320	79-85		7.55
SS1321	85-91		7.80
SS1322	91-97		7.90
SS1323	97-104		8.10
SS1324	104-112		8.30
SS1325	112-121		8.40
SS1326	121-130		8.60
SS1327	130-140		11.95
SS1328	140-150		12.25
SS1329	150-162		12.55
SS1330	162-174		12.65
SS1331	174-187		12.90
SS1332	187-200		13.20
SS1333	200-213		13.30
SS1334	213-226		13.50
SS1335	226-239		13.70
SS1336	239-252		13.90

Slangklemmen



Supra CT wormschroefklemmen:

De Supra CT slangklemmen zijn chroom 6-vrij. Supra slangklemmen zijn geproduceerd volgens EU richtlijn 2002/95/EC van 1 juli 2006.

Design:

Dankzij de vormgeving is het bij de Supra CT onmogelijk de schroef of de draaipin te verliezen. De klem is eenvoudig te bevestigen en te verwijderen. Geschikt voor veeleisende toepassingen.

Veiligheid:

De afgeschuinde hoeken van de slangklemband voorkomen schade aan de slang, gevaarlijke situaties worden voorkomen.

Oorklemmen



Enkel - staal verzinkt

5555	UL SPAN BEHEER	€
3012072	8-10	0.09
3012013	9-11	0.09
3012021	10-12	0.10
3012030	11-12	0.10
3012048	12-14	0.13
3012056	14-16	0.14
3012064	16-18,5	0.15



Enkel - RVS AISI-304

5555	UL SPAN BEHEER	€
23012440	7-9	0.30
23012087	8-10	0.30
23012010	9-11	0.30
23012028	10-12	0.30
23012036	11-13	0.35
23012044	12-14	0.35
23012079	12-15	0.35
23012052	14-16	0.40
23012458	15-17	0.40
23012060	16-18	0.40
23012423	17-19	0.45
23012431	18-20	0.45



Dubbel - staal verzinkt

5555	UL SPAN BEHEER	€
3012101	5-7	0.09
3012110	7-9	0.11
3012128	9-11	0.11
3012136	11-12	0.12
3012144	12-15	0.13
3012152	14-17	0.15
3012160	15-18	0.15
3012179	17-20	0.15
3012187	18-21	0.20
3012195	20-23	0.20
3012208	22-25	0.25
3012216	23-27	0.25
3012224	23-28	0.30
3012232	28-31	0.30
3012240	31-34	0.35
3012259	34-37	0.40
3012267	37-40	0.50
3012275	40-43	0.55
3012283	43-46	0.60

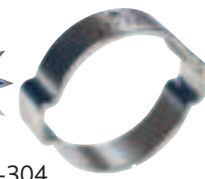

Dubbel - RVS AISI-304

5555	UL SPAN BEHEER	€
23012108	5-7	0.20
23012116	7-9	0.20
23012124	9-11	0.25
23012132	11-13	0.30
23012140	12-15	0.30
23012159	14-17	0.30
23012167	15-18	0.35
23012175	17-20	0.40
23012183	18-21	0.40
23012191	20-23	0.45
23012204	22-25	0.60

Supra CT wormschroefklemmen

Sluitring en draaipin
RVS en chroom 6 vrij.



Supra CT W2 - RVS AISI-430 - stalen schroef

5555	UL SPAN BEHEER	€
CT0302010-0	17-19	3.30
CT0302011-8	19-21	3.30
CT0302012-6	21-23	3.35
CT0302013-4	23-25	3.40
CT0302014-2	25-27	2.95
CT0302015-0	27-29	3.60
CT0302016-9	29-31	3.95
CT0302017-7	31-34	4.00
CT0302018-5	34-37	4.15
CT0302019-3	37-40	4.30
CT0302020-6	40-43	4.60
CT0302021-4	43-47	4.45
CT0302022-2	47-51	4.55
CT0302023-0	51-55	5.10
CT0302024-9	55-59	5.30
CT0302025-7	59-63	5.70
CT0302026-5	63-68	5.30
CT0302027-3	68-73	7.95
CT0302028-1	73-79	8.05
CT0302029-0	79-85	6.85
CT0302030-2	85-91	8.20
CT0302031-0	91-97	8.30
CT0302032-9	97-104	10.10
CT0302033-7	104-112	9.00
CT0302034-5	112-121	10.55
CT0302035-3	121-130	10.70
CT0302036-1	130-140	18.20
CT0302037-0	140-150	18.80
CT0302038-8	150-162	19.00
CT0302039-6	162-174	19.15
CT0302040-9	174-187	19.30
CT0302041-7	187-200	19.50
CT0302042-5	200-213	18.80
CT0302043-3	213-226	19.00
CT0302044-1	226-239	19.15
CT0302045-0	239-252	20.25

Hydrauliek
Snelkoppelingen
Afsluiters
Roestvast staal
Fittingen
Luchtconditionering
Gereedschap
Vacuumtechniek
Pneumatiek
Onderdelen compressoren
Diversen
Malleabele fittingen & Staal
Ringleidingssystemen
Slangen
Water, Gas, Sanitair, Verwarming

14 Slangklemmen



Hydrauliek **Oorklemmen met binnenring**

Snelkoppelingen

Afsluiters

Roestvast staal

Fittingen

Luchtconditionering

Gereedschap

Vacuümtechniek

Pneumatiek

Onderdelen compressoren

Diversen

Malleabele fittingen & Staal

Ringleidingssystemen

Slangen

Water, Gas, Sanitair, Verwarming



Enkel - staal verzinkt - binnenring RVS AISI-301

3011010	7,5-9,5	0.20
3011029	8,5-10,5	0.20
3011037	9,5-11,5	0.20
3011045	10,4-12,4	0.20
3011053	11,4-13,4	0.25
3011061	13,4-15,4	0.25
3011070	15,4-17,4	0.30

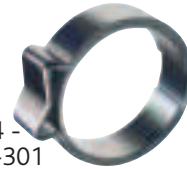

Enkel - RVS AISI-304 - binnenring RVS AISI-301

23012300	6,5-8,5	0.30
23012319	7,5-9,5	0.35
23012327	8,5-10,4	0.40
23012335	9,5-11,4	0.40
23012343	10,4-12,4	0.45
23012351	11,4-13,4	0.50
23012360	12,4-14,4	0.55
23012378	13,4-15,4	0.55
23012386	14,4-16,4	0.55
23012394	15,4-17,4	0.70
23012407	16,4-18,4	0.70
23012415	17,4-19,4	0.70

Automotive slangklemmen



Uitlaatklemmen

Deze klem wordt gebruikt om twee metalen buizen veilig aan elkaar te koppelen en is bestand tegen constante trillingen en hoge temperaturen.

Hierdoor wordt voorkomen dat de uitlaat gaat lekken.



Verzinkt staal

03002765	27	30	2.70
03002773	30	33	2.80
03002781	33	36	3.05
03002790	39	42	3.30
03002802	42	45	4.15
03002810	45	48	4.30
03002829	47,5	50	4.05
03002837	48	51	4.45
03002845	49	52	4.55
03002853	52	54	4.55
03002861	53	56	5.05
03002870	55	58	5.15
03002888	57	59	4.75
03002896	58	61	5.25
03002909	61	64	5.35
03002917	67	71	7.55
03002925	71	74	7.90

W3 S-band constante spanning wormschroefklem

De W3 S-band constante spanning wormschroefklem heeft een extra binnenring met veer, die ervoor zorgt dat er druk op de slang blijft ondanks verschillende temperaturen en trillingen.

Schroef: AISI 430 RVS

Band en huis: X6Cr-17 RVS (DIN 1.4016) AISI 430

Veer AISI 301 RVS



RVS - DIN 3017 zware uitvoering

03017834	30	45	3.60
03017842	32	50	3.70
03017850	40	60	3.95
03017869	50	70	4.35
03017877	60	80	4.70
03017885	70	90	5.00
03017893	80	100	5.25
03017906	90	110	5.95
03017914	100	120	6.20
03017922	110	130	6.45

Aluminium slangpilaren



Jaymac aluminium slangpilaren - met messing buitenlaag - BSPT male



AGT13/06K	ALU-SPI 6 X 1/4	0.60
AGT13/08K	ALU-SPI 8 X 1/4	0.50
AGT13/09K	ALU-SPI 9 X 1/4	0.60
AGT13/13K	ALU-SPI 13 X 1/4	0.70
AGT17/09K	ALU-SPI 9 X 3/8	0.85
AGT17/13K	ALU-SPI 13 X 3/8	0.75
AGT21/13K	ALU-SPI 13 X 1/2	1.20
AGT21/19K	ALU-SPI 19 X 1/2	1.20
AGT26/19K	ALU-SPI 19 X 3/4	2.10
AGT33/25K	ALU-SPI 25 X 1	4.25



Draadtype:

Conisch volgens ISO 7.1 / BS 21 / DIN2999.

Toepassing:

Perslucht, water, olie en vloeistoffen in het algemeen op pneumatisch gebied.



0°C tot +80°C



10

ALUMINIUM HOSE TAILS

"A New alternative to Brass"

As we all know the days of Brass being a low cost commodity material have gone. So we have looked at many options and are now proud to present this new concept solution!

- A new concept in design, these lightweight hose tails are manufactured to a high strength specification.
- Tapered in conformity with ISO 7.1, BS 21, DIN 2999.
- Compressed air, water, oils & fluids in general for the pneumatic fields.
- Has the appearance of brass.
- Lightweight.

N.B.: Safe pressures and temperatures depend entirely on the hose being used, for this reason the values must be determined in accordance with the hose features.





Hose Clips



Wormschroefklemmen



Jubilee® High Torque assortiment



RVS - bandbreedte 16mm

6666	SPAN RESEAL	€
JHT35	20-35	4.90
JHT40	25-40	4.95
JHT45	25-45	5.05
JHT50	30-50	5.10
JHT70	40-70	5.35
JHT80	60-80	5.80
JHT95	70-95	5.95
JHT100	80-100	5.90
JHT120	90-120	6.20
JHT140	110-140	6.50
JHT160	130-160	7.00
JHT180	150-180	7.00
JHT200	170-200	7.70
JHT220	190-220	8.05
JHT240	210-240	8.40
JHT260	230-260	8.70
JHT280	250-280	8.65
JHT300	270-300	9.30
JHT320	290-320	9.25
JHT340	310-340	9.55
JHT360	330-360	10.25
JHT380	350-380	10.15
JHT400	370-400	10.90
JHT420	390-420	10.75
JHT440	410-400	11.50
JHT480	450-480	12.15
JHT500	470-500	12.45

Jubilee® Multiband

Een op maat te maken wormschroefklem: knip de band op de gewenste lengte en plaats het in het onderstaande wormschroef huis.

Uit verzinkt staal.

Op aanvraag leverbaar: RVS band en huis.



Dispenser - 10 meter - bandbreedte 11mm

6666	per 10mtr	€
2025-3720		28.10

Dispenser - 30 meter - bandbreedte 11mm

6666	per 30mtr	€
2025-3738		80.70

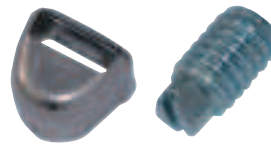

Wormschroefklem behuizing en schroef - 25 stuks voor alle diameters

6666	25	€
2025-3746		25.45

- Hydrauliek
- Snelkoppelingen
- Afsluiters
- Roestvast staal
- Fittingen
- Luchtconditionering
- Gereedschap
- Vacuümtechniek
- Pneumatiek
- Onderdelen compressoren
- Diversen
- Malleabele fittingen & Staal
- Ringleidingssystemen
- Slangen
- Water, Gas, Sanitair, Verwarming

14 Wormschroefklemmen



Hydrauliek Jubilee® wormschroefklemmen

Snelkoppelingen No. 1 in the U.K.

Afsluiters Top kwaliteit, Kitemark gekeurd volgens BS 5315:1991 en geproduceerd volgens BS EN ISO 9002.

Roestvast staal De staal serie is verzinkt ten behoeve van corrosiebestendigheid. De RVS serie is geheel uit RVS-304 (A2).

Fittingen MEER INFO: TECHNISCH DATABLAD 591.

Luchtconditionering

Gereedschap

Vacuumtechniek

Pneumatiek

Onderdelen compressoren

Diversen

Malleabele fittingen & Staal

Ringleidingssystemen

Slangen

Water, Gas, Sanitair, Verwarming



Jubilee® set

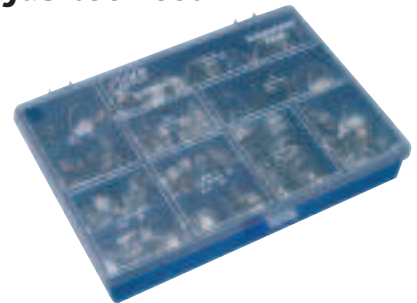

Staal verzinkte klemmen in kunststof box

Maten en hoeveelheden.

OOO-MS	24x
MOO-MS	32x
OO-MS	28x
O-MS	13x
OX-MS	14x
1A-MS	12x
1-MS	13x
1X-MS	7x

Assortiment



HCP143



120.35

Staal verzinkt

	6666	SPAN REZERF	€
OOO-MS	10	9	9,5-12 0.60
MOO-MS	10	9	11-16 0.60
OO-MS	10	9	13-20 0.65
O-MS	10	13	16-22 0.70
OX-MS	10	13	18-25 0.70
1A-MS	10	13	22-30 0.75
1-MS	10	13	25-35 0.80
1X-MS	10	13	30-40 0.90
1M-MS	10	13	32-45 0.90
2A-MS	10	13	35-50 0.90
2-MS	10	13	40-55 0.95
2X-MS	10	13	45-60 1.00
3-MS	10	13	55-70 1.15
3X-MS	1	13	60-80 1.25
4-MS	1	13	70-90 1.25
4X-MS	1	13	85-100 1.35
5-MS	1	13	90-120 1.55
6-MS	1	13	110-140 1.70
6X-MS	1	13	120-150 1.75
7-MS	1	13	135-165 1.85
71/2-MS	1	13	158-190 2.40
81/2-MS	1	13	184-216 2.60
91/2-MS	1	13	210-242 2.80
101/2-MS	1	13	235-267 3.00
111/2-MS	1	13	260-292 3.05
121/2-MS	1	13	286-318 4.00

Genoemde prijzen zijn per stuk

RVS AISI-304

	6666	SPAN REZERF	€
OOO-SS	10	9	9,5-12 1.80
MOO-SS	10	9	11-16 1.80
OO-SS	10	9	13-20 1.80
O-SS	10	13	16-22 2.20
OX-SS	10	13	18-25 2.30
1A-SS	10	13	22-30 2.40
1-SS	10	13	25-35 2.55
1X-SS	10	13	30-40 2.60
1M-SS	10	13	32-45 2.70
2A-SS	10	13	35-50 3.05
2-SS	10	13	40-55 2.60
2X-SS	10	13	45-60 3.15
3-SS	10	13	55-70 3.35
3X-SS	1	13	60-80 3.60
4-SS	1	13	70-90 3.70
4X-SS	1	13	85-100 3.90
5-SS	1	13	90-120 4.35
6-SS	1	13	110-140 4.70
6X-SS	1	13	120-150 4.85
7-SS	1	13	135-165 5.10
71/2-SS	1	13	158-190 5.75
81/2-SS	1	13	184-216 6.55
91/2-SS	1	13	210-242 7.40
101/2-SS	1	13	235-267 8.05
121/2-SS	1	13	286-318 8.90

Genoemde prijzen zijn per stuk

Slangklemmen

Assortimentsverpakking wormschroefklemmen Hi-Grip - staal



Maten van 12mm tot 50mm

135-delige set - zacht verzinkt staal



HGZAB1

114.70

Assortimentsverpakking wormschroefklemmen Hi-Grip - RVS



Maten van 12mm tot 50mm

135-delige set - 18/8 marine kwaliteit
RVS BS304



HGSAB1

333.85

Assortimentsverpakking mini wormschroefklemmen - staal



Diameters: 7mm-9mm, 8mm-10mm, 9mm-11mm,
10mm-12mm, 11mm-13mm, 12mm-14mm,
13mm-15mm, 14mm-16mm, 15mm-17mm,
16mm-18mm

157-delige set - zacht verzinkt staal



MCZAB1

106.80

Hydrauliek
Snel-
koppelingen
Afsluiters
Roestvast
staal
Fittingen
Lucht-
conditionering
Gereedschap
Vacuüm-
techniek
Pneumatiek
Onderdelen
compressoren
Diversen
Malleabele
fittingen
& Staal
Ringleiding-
systemen
Slangen
Water, Gas,
Sanitair,
Verwarming

14 Slangklemmen



Wormschroefklemmen Hi-Torque Heavy Duty - RVS

Materiaal: RVS BS304
(schroef RVS BS410)



	5555	B mm	min mm	max mm	€
Hydrauliek					
Snelkoppelingen					
Afsluiters					
Roestvast staal					
Fittingen					
Luchtconditionering					
Gereedschap					
Vacuumtechniek					
Pneumatiek					
Onderdelen compressoren					
Diversen					
Malleabele fittingen & Staal					
Ringleidingssystemen					
Slangen					
Water, Gas, Sanitair, Verwarming					
HT27	16	20	27	5.40	
HT30	16	20	30	5.40	
HT35	16	20	35	5.40	
HT40	16	25	40	5.40	
HT45	16	25	45	5.50	
HT50	16	30	50	5.55	
HT60	16	40	60	5.70	
HT65	16	45	65	5.85	
HT70	16	50	70	5.90	
HT80	16	60	80	6.05	
HT90	16	70	90	6.20	
HT95	16	75	95	6.35	
HT100	16	80	100	6.40	
HT120	16	90	120	6.70	
HT140	16	110	140	7.00	
HT160	16	130	160	7.40	
HT180	16	150	180	7.65	
HT200	16	170	200	8.00	
HT220	16	190	220	8.40	
HT240	16	210	240	8.65	
HT260	16	230	260	9.00	
HT280	16	250	280	9.35	
HT320	16	290	320	10.00	
HT340	16	310	340	10.35	
HT360	16	330	360	10.60	
HT380	16	350	380	11.00	
HT400	16	370	400	11.30	
HT420	16	390	420	11.60	
HT440	16	410	440	11.95	
HT460	16	430	460	10.60	
HT480	16	450	480	12.60	
HT500	16	470	500	12.95	

Wormschroefklemmen Hi-Grip - staal

Materiaal: Zacht verzinkt staal



Met vleugelschroef

	5555	B mm	min mm	max mm	€
510-12	9	9.5	12	0.95	
510-16	9	11	16	1.00	
510-20	9	13	20	1.00	
510-22	13	14	22	1.05	
510-25	13	17	25	1.10	
510-30	13	22	30	1.10	
510-35	13	25	35	1.15	
510-40	13	30	40	1.15	
510-45	13	35	45	1.15	
510-50	13	35	50	1.30	
510-55	13	40	55	1.20	
510-60	13	45	60	1.30	

Mini wormschroefklemmen Hi-Grip - staal

Materiaal: Zacht verzinkt staal



Voor kleine maten slang

	5555	B mm	min mm	max mm	€
505-9	9	7	9	0.40	
505-10	9	8	10	0.40	
505-11	9	9	11	0.40	
505-12	9	10	12	0.40	
505-13	9	11	13	0.40	
505-14	9	12	14	0.40	
505-15	9	13	15	0.40	
505-16	9	14	16	0.40	
505-17	9	15	17	0.40	
505-18	9	16	18	0.40	

Wormschroefklemmen Hi-Grip WDHC - staal



Zacht staal

	5555	B mm	min mm	max mm	€
WDHC000	9	9.5	12	0.55	
WDHC000	9	11	16	0.55	
WDHC000	9	13	20	0.55	
WDHCO	13	14	22	0.60	
WDHCOX	13	17	25	0.65	
WDHC1A	13	22	30	0.65	
WDHC1	13	25	35	0.70	
WDHC1X	13	30	40	0.70	
WDHC2A	13	35	50	0.80	
WDHC2	13	40	55	0.80	
WDHC2X	13	45	60	0.85	
WDHC3	13	50	70	0.95	
WDHC3X	13	60	80	1.05	
WDHC4	13	70	90	1.15	
WDHC4X	13	80	100	1.20	
WDHC5	13	90	120	1.50	

RVS BS304

	5555	B mm	min mm	max mm	€
WDHC000-SS	9	9.5	12	1.95	
WDHC000-SS	9	11	16	1.95	
WDHC000-SS	9	13	20	1.95	
WDHCO-SS	13	14	22	2.30	
WDHCOX-SS	13	17	25	2.30	
WDHC1A-SS	13	22	30	2.35	
WDHC1-SS	13	25	35	2.45	
WDHC1X-SS	13	30	40	2.55	
WDHC2A-SS	13	35	50	2.85	
WDHC2-SS	13	40	55	2.95	
WDHC2X-SS	13	45	60	3.10	
WDHC3-SS	13	50	70	3.40	
WDHC3X-SS	13	60	80	3.55	
WDHC4-SS	13	70	90	3.80	
WDHC4X-SS	13	80	100	4.00	
WDHC5-SS	13	90	120	4.50	
WDHC6-SS	13	110	140	4.95	
WDHC7-SS	13	130	160	5.40	

Slangklemmen

Display Hi-Grip - staal

100 stuks staal verzinkte
wormschroefklemmen -
maten van 12mm tot 50mm
(10 stuks per maat)
1 flexibele schroevendraaier



100
wormschroefklemmen
display



DISPKZ1

141.30

Display Hi-Grip - RVS

100 stuks RVS BS304
wormschroefklemmen -
maten van 12mm tot 50mm
(10 stuks per maat)
1 flexibele schroevendraaier



100
wormschroefklemmen
display



DISPKS1

324.95

160 stuks staal verzinkte
wormschroefklemmen -
maten van 12mm tot 100mm
(10 stuks per maat)
1 flexibele schroevendraaier



160
wormschroefklemmen
display



DISPKZ2

212.95

160 stuks RVS BS304
wormschroefklemmen -
maten van 12mm tot 100mm
(10 stuks per maat)
1 flexibele schroevendraaier



160
wormschroefklemmen
display



DISPKS2

546.25

- Hydrauliek
- Snelkoppelingen
- Afsluiters
- Roestvast staal
- Fittingen
- Luchtconditionering
- Gereedschap
- Vacuümtechniek
- Pneumatiek
- Onderdelen compressoren
- Diversen
- Malleabele fittingen & Staal
- Ringleidingssystemen
- Slangen
- Water, Gas, Sanitair, Verwarming

14 Wormschroefklemmen



Hydrauliek **ABA Nova wormschroefklem**

Snelkoppelingen Band: 8-12 tot 40mm: Galfan
32-44 tot 85mm: Aluzink

Afsluiters Wormhuis: Blauw gelakt
Schroef: Verzinkt staal



Roestvast staal

Fittingen

Luchtconditionering

Gereedschap 9mm bandbreedte - S20/9

ABA3240015		08-14	0.70
ABA3240017		11-17	0.75
ABA3240022		13-20	0.80
ABA3240025		15-24	0.90
ABA3240028		19-28	0.85
ABA3240032		22-32	0.85
ABA3240040		26-38	1.00
ABA3240045		32-44	1.00
ABA3240051		38-50	1.00
ABA3240056		44-56	1.15
ABA3240065		50-65	1.25
ABA3240075		58-75	1.30
ABA3240085		68-85	1.30

Slangen 12mm bandbreedte - S20/12

ABA3110024		15-24	0.90
ABA3110028		19-28	1.00
ABA3110032		22-32	1.00
ABA3110038		26-38	1.10
ABA3110044		32-44	1.05
ABA3110050		38-50	1.15
ABA3110056		44-56	1.30
ABA3110065		50-65	1.50
ABA3110075		58-75	1.50
ABA3110085		68-85	1.50

ABA RVS wormschroefklem

Geheel RVS 304



Nova - 9mm bandbreedte - W4/9

ABA3440015		08-14	2.60
ABA3440017		11-17	2.60
ABA3440022		13-20	2.65
ABA3440025		15-24	2.65
ABA3440028		19-28	2.65
ABA3440032		22-32	2.65
ABA3440040		26-38	2.65

Original - 12mm bandbreedte - W4/12

ABA3411024		15-24	2.85
ABA3411028		19-28	2.90
ABA3411032		22-32	2.95
ABA3411038		26-38	3.20
ABA3411044		32-44	3.25
ABA3411050		38-50	3.60
ABA3411056		44-56	3.90
ABA3411065		50-65	4.30
ABA3411075		58-75	4.55
ABA3411085		68-85	4.30

Slangklemmen



Industriële slangklemmen voor vele toepassingen



Staal & RVS ISO - 9002

Toepassing: Zeer veel gebruikt in industrie, landbouw en automotive. Scherpe prijzen door massaproductie. De prijs is het bewijs, ook RVS zeer scherpe prijzen. Veelzijdige toepassing door verschillende materialen. Compleet programma

Materiaalklasse

- Dubbele oorklem W1 = Staal verzinkt.
- Wormschroefklemmen DIN-3017.1 W2/9 4048 = Huis en band van RVS-AISI-430 bandbreedte 9 mm (DIN-1.416) wormschroef verzinkt staal.
- Wormschroefklemmen DIN-3017.1 W2/12 4058 = Huis en band van RVS-AISI-430 bandbreedte 12 mm (DIN-1.416) wormschroef verzinkt staal.
- Wormschroefklemmen DIN-3017.1 W4/9 6048 = Alle delen van RVS-AISI-304 bandbreedte 9 mm (DIN-1.4301)
- Wormschroefklemmen DIN-3017.1 W4/12 6058 = Alle delen van RVS-AISI-304 bandbreedte 12 mm (DIN-1.4301)

Materiaal codes

- W1: alle delen van verzinkt staal.
- W2: wormschroef van verzinkt staal, band & huis van RVS-AISI-430 (DIN-1.416)
- W4: alle delen van RVS-AISI-304 (DIN-1.4301)
- Dubbele oorslangklemmen in verzinkt gechromateerd staal. Hoogwaardige industriële kwaliteit.
- Materiaalcode: W1



Dubbel - oor slangklemmen in verzinkt gechromateerd staal

OORK	SPAN BEREIK	B mm	€
40350305	3-5	5	0.25
40350507	5-7	6	0.25
40350709	7-9	7	0.25
40350911	9-11	8	0.25
40351113	11-13	9	0.30
40351315	13-15	7,5	0.30
40351518	15-18	8	0.35
40351720	17-20	8,5	0.35
40352023	20-23	9	0.50
40352327	23-27	10	0.55
40352528	25-28	10	0.60
40352731	27-31	10	0.65
40353134	31-34	10	0.70
40353437	34-37	10	0.75
40353740	37-40	10	0.80
40354043	40-43	10	0.90
40354346	43-46	10	0.90

Wormschroefslangklemmen DIN-3017.1

Materiaalcode: W2



Wormschroefslangklem RVS, bandbreedte 9, met verzinkte stalen schroef

WORM	SPAN BEREIK	B mm	€
40480812	8-12	9	0.50
40481016	10-16	9	0.60
40481220	12-20	9	0.60
40481625	16-25	9	0.60
40582032	20-32	9	0.70
40482540	25-40	9	0.70
40484060	40-60	9	0.90
40481012	100-120	9	1.30
40481214	120-140	9	1.50
40481416	140-160	9	1.80

Wormschroefslangklem RVS, bandbreedte 12, met verzinkte stalen schroef

WORM	SPAN BEREIK	B mm	€
40583250	32-50	12	1.10
40585070	50-70	12	1.25
40586080	60-80	12	1.35
40587090	70-90	12	1.45
40488010	80-100	12	1.50
40589010	90-110	12	1.80
40581113	110-130	12	2.05
40581315	130-150	12	2.30
40581416	140-160	12	2.30

Wormschroefslangklemmen DIN-3017.1

Materiaalcode: W4



Wormschroefslangklem geheel RVS-AISI-304, bandbreedte 9 mm

WORM	SPAN BEREIK	B mm	€
60480812	8-12	9	1.25
60481220	12-20	9	1.35
60482032	20-32	9	1.45
60482540	25-40	9	1.45
60484060	40-60	9	1.55

Wormschroefslangklem geheel RVS-AISI-304, bandbreedte 12 mm

WORM	SPAN BEREIK	B mm	€
60582032	20-32	12	1.55
60583250	32-50	12	1.65
60585070	50-70	12	1.80
60587090	70-90	12	2.55
60589011	90-110	12	2.80
60581113	110-130	12	3.25
60581315	130-150	12	3.60
60581416	140-160	12	3.80

Hydrauliek
Snelkoppelingen
Afsluiters
Roestvast staal
Fittingen
Luchtconditionering
Gereedschap
Vacuumtechniek
Pneumatiek
Onderdelen compressoren
Diversen
Malleabele fittingen & Staal
Ringleidingssystemen
Slangen
Water, Gas, Sanitair, Verwarming

14 Slangklemmen



Schroevendraaier flexibel

Hydrauliek
Snef-koppelingen
Afsluiters
Roestvast staal
Fittingen
Lucht-conditionering
Gereedschap



WORM SK-flex €

40580008 6.10

Jaymac wormschroefklemmen display

Pneumatiek
Onderdelen compressoren
Diversen
Malleabele fittingen & Staal
Ringleiding-systemen
Slangen
Water, Gas, Sanitair, Verwarming



INHOUD:

1x	Flexibele schroevendraaier	12x	25-40mm
1x	Wandrek	12x	32-50mm
12x	8-12mm	12x	35-45mm
12x	10-16mm	12x	40-60mm
12x	12-20mm	12x	50-70mm
12x	16-25mm	9x	60-80mm
12x	20-32mm	9x	70-90mm

Wandmontage - materiaalcode: W2

WORM €

HC-DS 71.65

Heavy duty steel hose clamps

Materiaalcode: W1



Zware eenbouts slangklemmen - staal

ABA MS-SPAN BEHEK €

HDSHS-1719	17-19	1.50
HDSHS-2022	20-22	1.50
HDSHS-2325	23-25	1.55
HDSHS-2628	26-28	1.55
HDSHS-2931	29-31	1.85
HDSHS-3235	32-35	1.85
HDSHS-3639	36-39	1.85
HDSHS-4043	40-43	1.95
HDSHS-4447	44-47	2.55
HDSHS-4851	48-51	2.80
HDSHS-5255	52-55	2.80
HDSHS-5659	56-59	2.85
HDSHS-6063	60-63	2.80
HDSHS-6467	64-67	2.80
HDSHS-6873	68-73	3.60
HDSHS-7479	74-79	3.60
HDSHS-8085	80-85	3.55
HDSHS-8691	86-91	3.90
HDSHS-9297	92-97	3.55
HDSHS-98103	98-103	4.10
HDSHS-104112	104-112	4.15
HDSHS-113121	113-121	3.90
HDSHS-122130	122-130	4.40
HDSHS-131139	131-139	4.40
HDSHS-140148	140-148	4.40
HDSHS-149161	149-161	5.25
HDSHS-162174	162-174	4.85
HDSHS-175187	175-187	4.75
HDSHS-188200	188-200	5.25
HDSHS-201213	201-213	5.80
HDSHS-214226	214-226	5.40
HDSHS-227239	227-239	5.30
HDSHS-240252	240-252	5.25

Slangklemmen

Heavy duty RVS slangklemmen

JAYMAC



Materiaalcode: W4

Zware eenbouts slangklemmen - RVS 304



WORM	SPAN BEHEER	€
SHC-1719	17-19	3.20
SHC-2022	20-22	3.40
SHC-2325	23-25	3.30
SHC-2628	26-28	3.30
SHC-2931	29-31	3.90
SHC-3235	32-35	4.20
SHC-3639	36-39	4.10
SHC-4043	40-43	4.10
SHC-4447	44-47	6.35
SHC-4851	48-51	6.70
SHC-5255	52-55	7.25
SHC-5659	56-59	7.25
SHC-6063	60-63	7.20
SHC-6467	64-67	7.20
SHC-6873	68-73	8.15
SHC-7479	74-79	8.15
SHC-8085	80-85	8.50
SHC-8691	86-91	8.50
SHC-9297	92-97	8.60
SHC-98103	98-103	9.20
SHC-104112	104-112	8.90
SHC-113121	113-121	9.50
SHC-122130	122-130	9.60
SHC-131139	131-139	11.70
SHC-140148	140-148	12.45
SHC-149161	149-161	13.60
SHC-162174	162-174	13.60
SHC-175187	175-187	13.60
SHC-188200	188-200	13.70
SHC-201213	201-213	13.20
SHC-214226	214-226	13.80
SHC-227239	227-239	15.90
SHC-240252	240-252	13.80



Heavy duty steel hose clamps



Zware tweebeuts slangklemmen - gegalvaniseerd



WORM	Document	SPAN BEHEER	€
MIPC-1722	MAL-STEEL W1-2B	17-22	1.85
MIPC-2229	MAL-STEEL W1-2B	22-29	2.05
MIPC-2934	MAL-STEEL W1-2B	29-34	2.15
MIPC-3440	MAL-STEEL W1-2B	34-40	2.70
MIPC-3949	MAL-STEEL W1-2B	39-49	3.90
MIPC-4860	MAL-STEEL W1-2B	48-60	4.35
MIPC-6076	MAL-STEEL W1-2B	60-76	4.85
MIPC-7794	MAL-STEEL W1-2B	77-94	8.05
MIPC-94115	MAL-STEEL W1-2B	94-115	8.90
MIPC-400	MAL-STEEL W1-2B	88-96	10.15
MIPC-463	MAL-STEEL W1-2B	102-108	10.70
MIPC-525	MAL-STEEL W1-2B	108-125	12.45
MIPC-550	MAL-STEEL W1-2B	114-128	13.05
MIPC-600	MAL-STEEL W1-2B	130-144	15.60
MIPC-675	MAL-STEEL W1-2B	151-165	16.15
MIPC-769	MAL-STEEL W1-2B	165-192	19.90
MIPC-875	MAL-STEEL W1-2B	210-225	28.50
MIPC-988	MAL-STEEL W1-2B	227-239	31.35
MIPC-1125	MAL-STEEL W1-2B	252-289	55.60
MIPC-1275	MAL-STEEL W1-2B	300-330	62.75
MIPC-1450	MAL-STEEL W1-2B	335-381	121.30

Wormschroefklemmen

NORMA



Torro W1 - staal verzinkt - DIN 3017



NORM	Document	SPAN BEHEER	B mm	€
NOR-000	HOSE CLIP 000	8-12	9	0.60
NOR-MOO	HOSE CLIP MOO	10-16	9	0.60
NOR-00	HOSE CLIP 00	12-22	9	0.60
NOR-O	HOSE CLIP O	16-27	12	0.75
NOR-1A	HOSE CLIP 1A	20-32	12	0.75
NOR-1	HOSE CLIP 1	25-40	12	0.80
NOR-2A	HOSE CLIP 2A	35-50	12	0.90
NOR-2	HOSE CLIP 2	40-60	12	1.00
NOR-3	HOSE CLIP 3	50-70	12	1.10
NOR-3X	HOSE CLIP 3X	60-80	12	1.25
NOR-4	HOSE CLIP 4	70-90	12	1.35
NOR-4X	HOSE CLIP 4X	80-100	12	1.40
NOR-5	HOSE CLIP 5	90-110	12	1.65

Hydrauliek
Snelkoppelingen
Afsluiters
Roestvast staal
Fittingen
Luchtconditionering
Gereedschap
Vacuumtechniek
Pneumatiek
Onderdelen compressoren
Diversen
Malleabele fittingen & Staal
Ringleidingssystemen
Slangen
Water, Gas, Sanitair, Verwarming

14 Slangklemmen



Hydrauliek Cobra schroefloze spanklemmen

- Snelkoppelingen
- Afsluiters
- Roestvast staal
- Fittingen



Cobra W4 - RVS 304

Gereedschap				
Vacuumtechniek				
Pneumatiek				
Onderdelen compressoren				
Diversen				
Malleabele fittingen & Staal				
Ringleidingssystemen				
Slangen				
Water, Gas, Sanitair, Verwarming				
COBRA75		7	7.5	0.75
COBRA8		7	8	0.75
COBRA85		7	8.5	0.75
COBRA9		7	9	0.75
COBRA95		7	9.5	0.75
COBRA10		7	10	0.75
COBRA105		7	10.5	0.75
COBRA11		7	11	0.75
COBRA115		7	11.5	0.75
COBRA12		8	12	0.80
COBRA13		8	13	0.80
COBRA14		8	14	0.80
COBRA15		8	15	0.80
COBRA16		8	16	0.80
COBRA17		8	17	0.80
COBRA18		8	18	0.80
COBRA19		8	19	0.80
COBRA20		8	20	0.80
COBRA21		8	21	0.85
COBRA22		8	22	0.85
COBRA23		8	23	0.85
COBRA24		8	24	0.85
COBRA25		8	25	0.85
COBRA26		8	26	0.85
COBRA27		8	27	0.85
COBRA28		8	28	0.90
COBRA29		8	29	0.90
COBRA30		8	30	0.90

Handgereedschap om Cobraklemmen te monteren



COB-TOOL	103.60

Wormschroefklemmen



Torro W4 - RVS 304 - DIN 3017

SS-75-12	HOSE CLIP SS 8-12mm	8-12	7,5	1.25
SS-75-16	HOSE CLIP SS 10-16mm	10-16	7,5	1.35
SS-75-18	HOSE CLIP SS 12-18mm	12-18	7,5	1.35
SS-000	HOSE CLIP SS 000	8-16	9	1.85
SS-00	HOSE CLIP SS 00	12-22	9	2.10
SS-O	HOSE CLIP SS O	16-27	12	2.40
SS-1A	HOSE CLIP SS 1A	20-32	12	2.40
SS-1	HOSE CLIP SS 1	25-40	12	2.60
SS-2A	HOSE CLIP SS 2A	32-50	12	2.75
SS-2	HOSE CLIP SS 2	40-60	12	2.95
SS-3	HOSE CLIP SS 3	50-70	12	3.10
SS-3X	HOSE CLIP SS 3X	60-80	12	3.40
SS-4	HOSE CLIP SS 4	70-90	12	3.80
SS-4X	HOSE CLIP SS 4X	80-100	12	4.05
SS-5	HOSE CLIP SS 5	90-110	12	4.25



Torro HD (heavy duty) W4 - RVS 304 - DIN 3017

HD45	25-45	16	10.25
HD54	32-54	16	10.50
HD67	45-67	16	10.50
HD79	57-79	16	10.90
HD92	70-92	16	11.30
HD105	83-105	16	11.80
HD118	95-118	16	12.25
HD130	108-130	16	12.60
HD143	121-143	16	12.70
HD156	133-156	16	13.05
HD168	146-168	16	13.20
HD181	159-181	16	13.60
HD194	172-194	16	14.45
HD206	184-206	16	14.95
HD219	197-219	16	15.30
HD232	210-232	16	15.60

Slangklemmen

GBS wormschroefklemmen heavy duty



GBS W1 - staal verzinkt - DIN 3017

GBS W4 - RVS 304 - DIN 3017

GBSW1-17-19	17-19	18	2.25
GBSW1-19-21	19-21	18	2.25
GBSW1-21-23	21-23	18	2.25
GBSW1-23-25	23-25	18	2.25
GBSW1-25-27	25-27	18	2.30
GBSW1-27-29	27-29	18	2.30
GBSW1-29-31	29-31	18	2.40
GBSW1-31-34	31-34	18	2.40
GBSW1-34-37	34-37	18	2.40
GBSW1-37-40	37-40	18	2.40
GBSW1-40-43	40-43	18	2.40
GBSW1-43-47	43-47	20	2.55
GBSW1-47-51	47-51	20	2.55
GBSW1-51-55	51-55	20	2.55
GBSW1-55-59	55-59	20	2.55
GBSW1-59-63	59-63	20	2.60
GBSW1-63-68	63-68	20	2.60
GBSW1-68-73	68-73	25	3.10
GBSW1-73-79	73-79	25	3.10
GBSW1-79-85	79-85	25	3.20
GBSW1-85-91	85-91	25	3.20
GBSW1-91-97	91-97	25	3.40
GBSW1-97-104	97-104	25	3.50
GBSW1-104-114	104-114	25	3.50
GBSW1-114-121	114-121	25	3.60
GBSW1-121-130	121-130	25	3.80
GBSW1-130-140	130-140	30	4.90
GBSW1-140-150	140-150	30	5.10
GBSW1-150-162	150-162	30	6.35
GBSW1-162-174	162-174	30	6.15
GBSW1-174-187	174-187	30	6.85
GBSW1-187-200	187-200	30	7.05
GBSW1-200-213	200-213	30	7.65
GBSW1-213-226	213-226	30	7.80
GBSW1-226-239	226-239	30	8.00
GBSW1-239-252	239-252	30	8.10

GBSW4-17-19	17-19	18	6.15
GBSW4-19-21	19-21	18	6.15
GBSW4-21-23	21-23	18	6.20
GBSW4-23-25	23-25	18	6.20
GBSW4-25-27	25-27	18	6.25
GBSW4-27-29	27-29	18	6.30
GBSW4-29-31	29-31	18	6.30
GBSW4-31-34	31-34	18	6.35
GBSW4-34-37	34-37	18	6.40
GBSW4-37-40	37-40	18	6.50
GBSW4-40-43	40-43	18	6.60
GBSW4-43-47	43-47	20	8.75
GBSW4-47-51	47-51	20	8.80
GBSW4-51-55	51-55	20	8.85
GBSW4-55-59	55-59	20	8.95
GBSW4-59-63	59-63	20	9.00
GBSW4-63-68	63-68	20	9.10
GBSW4-68-73	68-73	25	13.90
GBSW4-73-79	73-79	25	14.10
GBSW4-79-85	79-85	25	14.30
GBSW4-85-91	85-91	25	14.40
GBSW4-91-97	91-97	25	14.50
GBSW4-97-104	97-104	25	14.95
GBSW4-104-114	104-114	25	15.15
GBSW4-114-121	114-121	25	15.40
GBSW4-121-130	121-130	25	15.70
GBSW4-130-140	130-140	30	24.00
GBSW4-140-150	140-150	30	24.30
GBSW4-150-162	150-162	30	24.45
GBSW4-162-174	162-174	30	25.20
GBSW4-174-187	174-187	30	25.70
GBSW4-187-200	187-200	30	25.95
GBSW4-200-213	200-213	30	26.55
GBSW4-213-226	213-226	30	27.00
GBSW4-226-239	226-239	30	27.50
GBSW4-239-252	H239-252	30	28.10

Hydrauliek
Snelkoppelingen
Afsluiters
Roestvast staal
Fittingen
Luchtconditionering
Gereedschap
Vacuümtechniek
Pneumatiek
Onderdelen compressoren
Diversen
Malleabele fittingen & Staal
Ringleidingssystemen
Slangen
Water, Gas, Sanitair, Verwarming

14 Norma wormschroefklem montageset



Hydrauliek **Wormschroefklem band**

Snelkoppelingen Voor het op maat maken van wormschroefklemmen.

Afsluiters

Roestvast staal

Fittingen

Luchtconditionering



Lengte 30 meter - Breedte 12 mm - W1 / verzinkt staal

BAND-W1	WSK band W1	30	87.20

Pneumatiek

Onderdelen compressoren

Diversen

Malleabele fittingen & Staal

Ringleidingssystemen



Lengte 30 meter - Breedte 12 mm - W3 / verchroomd staal

BAND-W3	WSK band W3	30	115.60

Slotjes voor wormschroefklem band



Breedte 12 mm - W1 / verzinkt staal / per 50 stuks

NBG-12W1	WSK huis W1	50	47.00



Breedte 12 mm - W3 / verchroomd staal / per 50 stuks

NBG-12W3	Normetta NB-G	50	79.40

Veerslanghaspels

Veerslanghaspels

Voor perslucht en water. Zeer goede prijs/kwaliteit verhouding. Rubberen, verstelbare slangnok die krassen voorkomt. Compleet met wandmontagebeugel.

Huis: slagvaste kunststof.

Slang: slijtvaste antieknik versterkte PU slang.



12



0°C-50°C



Half open zelfprollende veerslanghaspel voor water en perslucht



27001308 12/8 x 1/4" 7.5 Rood 270 140 **105.00**



7



0°C-50°C

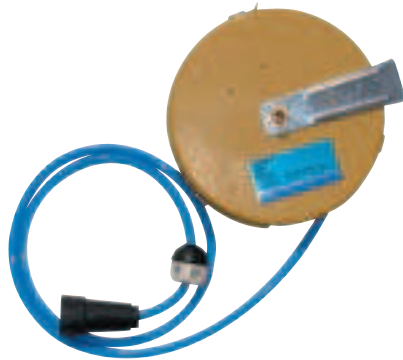

Gesloten zelfprollende veerslanghaspel voor perslucht



27001307 9.5/6.5 x 1/4" 6 Beige 210 60 **58.80**

Open handmatig oprolbare slanghaspel

Voor perslucht en water.

360° draaibaar.

Met inklapbare handgreep.

Huis: metaal gecoat

Slang: slijtvaste antieknik versterkte PU slang.



14



0°C-50°C

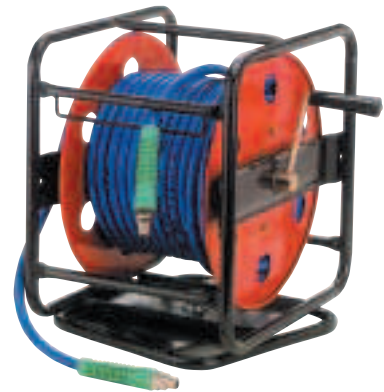

Open multifunctionele slanghaspel voor water en perslucht



27001730 12/8 X 1/4" 30 Rood 330 260 **106.15**

Hydrauliek

Snelkoppelingen

Afsluiters

Roestvast staal

Fittingen

Luchtconditionering

Gereedschap

Vacuümtechniek

Pneumatiek

Onderdelen compressoren

Diversen

Malleabele fittingen & Staal

Ringleidingssystemen

Slangen

Water, Gas, Sanitair, Verwarming

14 Veerslanghaspels



- Hydrauliek
- Snelkoppelingen
- Afsluiters
- Roestvast staal
- Fittingen
- Luchtconditionering
- Gereedschap
- Vacuumtechniek

Heavy Duty multifunctionele veerslanghaspels



Pneumatiek Met PU slang en draadaansluiting - 20 bar

SH400	Nw-10 x 3/8"	15	Zwart	10	212.50
SH460	Nw-13 x 1/2"	15	Zwart	13	261.60

Malleabele fittingen & Staal

Zonder slang

SH40X	Voor 15 mtr. Nw-10 slang	Zwart	195.25
SH46X	Voor 15 mtr. Nw-13 slang	Zwart	235.85

Open zelfprollende roestvaststalen veerslanghaspel



Zonder slang - geschikt voor tot aan 15 meter 1/2" inwendige slang (13mm)

HR-SS1	RVS-V. 15 Mtr. Nw-13 slang	RVS	446.30

Gesloten zelfprollende veerslanghaspel



Met PU slang en draadaansluiting

HR-1033	Nw-10 x 1/4"	10	Geel	12	157.25

Retracta slanghaspels



Redashe 14

De Redashe Retracta veerslanghaspels zijn betrouwbaarheid, kwalitatief en veelzijdig. Het huis is van UV resistent polipropyleen waardoor het corrosie vrij en duurzaam is. Geschikt voor zowel binnen- als buitentoepassingen. De haspels zijn ook geschikt voor toepassingen in de voedingsindustrie, dit is een alternatief voor de RVS haspels. Geschikt voor wand, vloer en werkbank montage.

Hydrauliek
Snelkoppelingen
Afsluiters
Roestvast staal
Fittingen
Luchtconditionering
Gereedschap
Vacuümtechniek
Pneumatiek
Onderdelen compressoren
Diversen
Malleabele fittingen & Staal
Ringleidingssystemen



AR100

Voordelen:

- De vergrendelings functie zorgt ervoor dat de haspel in alle mogelijke posities blijft staan, met blokkeerstanden op de gewenste slanglengtes.
- Sterke corrosie vrije constructie van polipropyleen.
- Lichtgewicht (12kg) en makkelijk te installeren.
- Lage oprol spanning, makkelijk om de slang uit te trekken.
- Onderhoudsarm.
- Reserve onderdelen zijn leverbaar.
- 5 jaar fabrieksgarantie. (onder voorwaarden)

N.B.: Leverbaar voor veel andere toepassingen, met of zonder slang.

Slang: Gewapend PVC

Retracta gesloten perslucht veerslanghaspel met BSP draad

0122	L m	ID mm	Inlaat	Uitlaat	bar		€	Slangen
AR100	20	10	3/8" Female	1/4" Male	16	Rood	352.75	Water, Gas, Sanitair, Verwarming
AR200	15	12.5	3/8" Female	3/8" Female	16	Rood	389.65	

Slang: Gewapend PVC

Retracta gesloten koud water veerslanghaspel met BSP draad - tot 40°C

0122	L m	ID mm	Inlaat	Uitlaat	bar		€
CW100	15	12.5	-	Slang	10	Blauw	389.65

Slang: Gewapend Rubber

Retracta gesloten heet water veerslanghaspel met BSP draad - tot 95°C

0122	L m	ID mm	Inlaat	Uitlaat	bar		€
HW100	12	12.5	3/8" Female	3/8" Male	10	Rood	428.15

Slang: Gewapend Rubber

Retracta gesloten heet water veerslanghaspel - voedingsmiddelen kwaliteit - met BSP draad - tot 95°C

0122	L m	ID mm	Inlaat	Uitlaat	bar		€
FQ100	12	12.5	3/8" Female	1/2" Male	20	Rood	513.10

Retracta gesloten tuinhaspel

0122	L m	ID mm	Inlaat	Uitlaat	bar		€
DR100	18	12.5	3/4" Male	Nozzel	7	Groen	366.50

Retracta gesloten ademlucht haspel (EN139)

0122	L m	ID mm	Inlaat	Uitlaat	bar		€
BH100	15	10	3/8" Female	3/8" Male	12	Rood	556.40

14 Retracta slanghaspels



Redashe

Hydrauliek E-zy haspel

Snelkoppelingen

Afsluiters

Roestvast staal

Fittingen

Luchtconditionering

Gereedschap

Vacuumtechniek

Pneumatiek

Onderdelen compressoren

Diversen

Malleabele fittingen & Staal

Ringleidingssystemen

Slangen

Water, Gas, Sanitair, Verwarming

Voordelen:

- Concurrerend geprijsd, lichtgewicht (12,5 kg) en duurzaam.
- Corrosie vrije constructie van polypropyleen.
- Leverbaar met verschillende slangen voor specifieke toepassingen.
- Volledig gebruiksklaar, met een 3 meter aansluitslang.



E-zy gesloten veerslanghaspels voor lucht & water

	L m	ID mm	BSPT	bar	€
C705-100	10	1/4"	1/4"	12	125.10
C705-200	8	5/16"	1/4"	12	131.50
C701-100	15	3/8"	3/8"	20	182.75
C701-200	15	1/2"	1/2"	20	198.80

808 serie zelfoprollende veerslanghaspel

Voordelen:

- Huis van plaatstaal. (corrosie bestendige poedercoating)
- De arm is verstelbaar in 9 posities.
- De veer is volledig ingesloten en gesmeerd.
- Geschikt voor wand, plafond of vloer installatie.



Open veerslanghaspels

	L m	ID mm	BSPT	bar	€
C808-350L	15	3/8"	3/8"	20	317.50
C808-450L	15	1/2"	1/2"	20	365.60
C808-350M	15	3/8"	3/8"	155	431.35
C808-450M	15	1/2"	1/2"	138	479.45

E-zy haspel 208 Serie, handmatig oprolbare slanghaspel

- Perfect ontwerp. Door de stalen constructie is dit een zeer sterke en duurzame haspel.
- Zwarte topkwaliteit corrosiebestendige poedercoating.
- De draaibare messing aansluiting heeft een volle doorlaat en zorgt voor een maximale flow.
- Geschikt voor wand, vloer of werkbank installatie. Zeer geschikt voor voertuigtoepassingen en hoge druk spuiten.
- De borgpen met veer voorkomt dat de slang van de haspel gaat.
- Lichtgewicht (9,5kg zonder slang)

Maximale werkdruk voor haspel: 200 bar



E-zy 208 handmatig oprolbare slanghaspel - zonder slang

	Inlaat	Uitlaat	€
C208-3-100H	Geschikt voor 30m x 10mm	3/8"	161.95
C208-4-65H	Geschikt voor 20m x 12,5mm	1/2"	158.75

E-zy haspel 460 Serie, handmatig oprolbare slanghaspel

Voordelen:

- Ontworpen voor industriële toepassingen waar lange slangen nodig zijn.
- Gebouwd van zware gepoedercoat staal
- De draaibare aansluiting heeft een volle doorlaat en zorgt voor een maximale flow.
- De borgpen met veer voorkomt dat de slang van de haspel gaat.

Maximale werkdruk voor haspel: 200 bar

E-zy 460 handmatig oprolbare slanghaspel - zonder slang

	Inlaat	Uitlaat	€
C460-3-350H	Geschikt voor 105m x 10mm	3/8"	230.90
C460-4-270H	Geschikt voor 80m x 12,5mm	1/2"	227.70



E-zy 460 handmatig oprolbare slanghaspel - met lucht / water slang

	€
C460-3-350H-AW	105m x 10mm 501.60
C460-4-270H-AW	80m x 12,5mm 628.95

E-zy 460 handmatig oprolbare slanghaspel - met diesel slang

	€
C460-3-350H-D	105m x 10mm 813.65
C460-4-270H-D	80m x 12,5mm 695.55

E-zy 460 handmatig oprolbare slanghaspel - met olie slang

	€
C460-3-350H-OIL	105 M x 10 MM 1357.90
C460-4-270H-OIL	80 M x 12,5 MM 1122.70

Veerslanghaspels



14

Voor perslucht en koud water

ZECA / Allflow zelfoprollende luchthaspel

Huis: Slagvast ABS kunststof

Slang: Gladde versterkte soepele polyurethaan slang met grote doorlaat. Nippel met buitendraad en anti-knikveer. Metalen zwenkbare muurbeugel. Automatische blokkeerinrichting elke 50 cm. naar keuze in- of uit te schakelen.



Maximale werkdruk 15



Hydrauliek
Snelkoppelingen
Afsluiters
Roestvast staal
Fittingen
Luchtconditionering

Zeca / Allflow gesloten zelfoprollende veerslanghaspel voor perslucht



27001306 VEERHASPEL 10m - 8mm (5/16") inw. 1/4" 8 9+1 GRIJS 310 125 **213.85**

Gereedschap
Vacuumtechniek
Pneumatiek
Onderdelen compressoren

ZECA / Allflow gesloten zelfoprollende lucht veerslanghaspel.

Huis: Epoxy gelakt aluminium spuitgietwerk.

Slang: Soepele versterkte PVC slang met polyurethaan binnenslang met grote doorlaat. Nippel met buitendraad en anti-knikveer. Metalen zwenkbare muurbeugel. Automatische blokkeerinrichting elke 50 cm. naar keuze in- of uit te schakelen



Maximale werkdruk 15



Diversen
Malleabele fittingen & Staal
Ringleidingssystemen
Slangen
Water, Gas, Sanitair, Verwarming

Zeca / Allflow gesloten zelfoprollende veerslanghaspel voor perslucht



27001310 VEERHASPEL 12M 13/8 - 1/4" 8 10+2 GRIJS 360 175 **429.85**
27001707 VEERHASPEL 9M 15,7/10 - 3/8" 3/8" 10 7+2 GRIJS 360 175 **430.90**

14 Veerslanghaspels



Hydrauliek **Zelfoprollende gesloten professionele veerslanghaspels** Snelkoppelingen **Type MP, MN, MD**

- Afsluiters** Toepassing: Perslucht
- Roestvast staal** Levering: Compleet met 180° draaibare bevestiging. Geschikt voor wand- en plafondmontage. Andere kleuren/slanguitvoeringen zijn op aanvraag leverbaar.
- Fittingen** Functies: Automatische terugloop, blokkeer-standen op de gewenste slanglengte. De professionele draaibare inlaatkoppeling zorgt voor perfecte dichting en soepel draaiwerk. Deze draai-koppelingen (swivels) zijn per uitvoering voorzien van verschillende dichtingen, aangepast aan het medium en de toepassing. Deze Faicom swivels zijn ook los verkrijgbaar, zie verderop in dit hoofdstuk.
- Luchtconditionering** Kwaliteit: Industriële kwaliteit. Geproduceerd en getest in de EU, 2 jaar garantie.
- Gereedschap** **Materiaal:** Haspel: Plaatstaal, in en uitwendig bad verzinkt en epoxy gecoat. UV bestendig. Onderdelen die in contact komen met het medium zijn extra tegen corrosie behandeld.
- Vacuumtechniek** Slang: Zeer slijtvaste polyester versterkte PU slang met antiknikveer.

- Pneumatiek** Tot 40°C
- Onderdelen compressoren** Tot 20 bar
- Diversen** Slang: Blauw
- Malleabele fittingen & Staal** Haspel: Rood of Blauw
- Ringleidingssystemen**
- Slangen**
- Water, Gas, Sanitair, Verwarming**

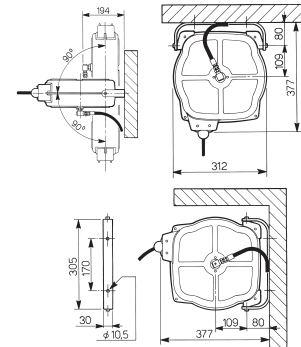
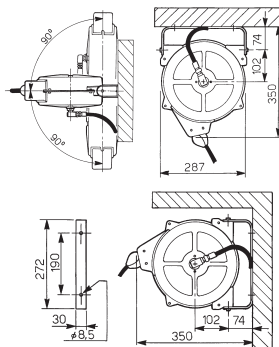
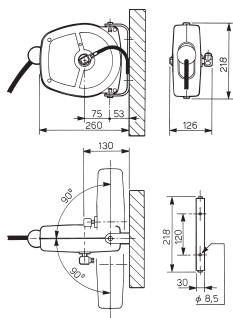

Zelfoprollende gesloten industriële veerslanghaspel, - type MP, MN, MD - voor perslucht

MP200805	VEERH-MP20-5 M. 11-8	Blauw	5	3	1/4" BSP Male	PU 11x8 BSP	PU 11x8	143.85
MP201003	VEERH-MP20-3 M. 14-10	Blauw	3	3	3/8" BSP Male	PU 14x10 BSP	PU 14x10	151.40
27021710	VEERH-MN20-10 M. 12-8	Rood	10	8	1/4" BSP Male	3/8" BSP Fem.	PU 12x8	216.30
27021712	VEERH-MD20-12 M. 12-8	Blauw	12	9	1/4" BSP Male	3/8" BSP Fem.	PU 12x8	260.65

Veerslanghaspels



FAICOM 14

Handmatig oprolbare open slanghaspel type HANDY

- Toepassingen:** Perslucht en water.
- Levering:** Verkrijgbaar met en zonder polyester versterkte PU slang. Inclusief 2 meter aansluitslang. De bevestigings - gleufgaten Ø 8.5 maken wandmontage mogelijk.
- Functie:** Inklapbare handel. Ruimtebesparende goedkope oplossing. Geen rondslingerende slangen. Veilig.
- Kwaliteit:** De FAICOM HANDY slanghaspel is van uitstekende kwaliteit. Geproduceerd en getest in de EU, 2 jaar garantie.
- Materiaal:**
Buizenframe: Elektrostatisch polyester gecoat, krasvast en UV bestendig.
Haspel: Het plaatstaal is in- en uitwendig bad verzinkt.
Slang: Zeer slijtvaste polyester versterkte PU slang met perskoppelingen.

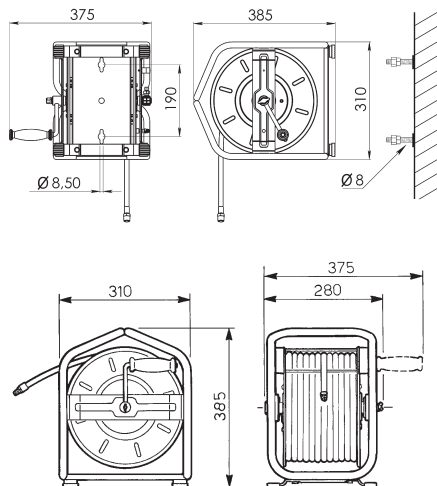

Hydrauliek
 Snelkoppelingen
 Afsluiters
 Roestvast staal
 Fittingen
 Luchtconditionering
 Gereedschap
 Vacuumtechniek
 Pneumatiek
 Onderdelen compressoren
 Diversen
 Malleabele fittingen & Staal
 Ringleidingssystemen
Slangen
 Water, Gas, Sanitair, Verwarming

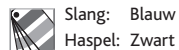

Met en zonder slang voor water en perslucht

VEER				Uitlaat	Inlaat	Slang	€
AM2010ST	Handy ZS	-	5.5	1/4" BSP Male	1/4" BSP Fem.	Geen	115.75
AM200830	Handy 12x8x30	30	8.4	1/4" BSP Male	1/4" BSP Male	T-PU12x8	157.90
AM200840	Handy 12x8x40	40	9	1/4" BSP Male	1/4" BSP Male	T-PU12x8	177.40
AM201025	Handy 14x10x25	25	8.4	3/8" BSP Male	3/8" BSP Male	T-PU14x10	172.00

14 Veerslanghaspels



Hydrauliek **Zelfprollende gesloten professionele veerslanghaspels type MC**

- Snelkoppelingen** Toepassingen: Geschikt voor perslucht, water (heet en koud), olie en vet.
- Afsluiters** Levering: Andere slangen (lengtes en maten) zijn op aanvraag leverbaar. Standaard levering met vaste bevestiging. Geschikt voor wand- en plafondmontage. Levering exclusief aansluitslang.
- Roestvast staal** Voor 180° draaibare bevestigingsbeugel (26061099L) en aansluitslang zie Faicom accessoires.
- Fittingen** Functies: Automatische terugloop, met blokkeerstanden op de gewenste slanglengtes. De professionele draaibare inlaatkoppeling zorgt voor perfecte dichting en soepel draaiwerk. Deze draai-koppelingen (swivels) zijn per uitvoering voorzien van verschillende dichtingen, aangepast aan het medium en de toepassing. Faicom swivels zijn los verkrijgbaar, zie Faicom accessoires.
- Luchtconditionering**
- Gereedschap** Kwaliteit: Industriële kwaliteit. Geproduceerd en getest in de EU, 2 jaar garantie.
- Vacuumtechniek** Materiaal: **Haspel:** Plaatstaal is in en uitwendig bad verzinkt en epoxy gecoat. UV bestendig. Onderdelen die in contact komen met het medium zijn extra tegen corrosie behandeld. Op aanvraag in andere kleuren leverbaar.
- Pneumatiek** **Slang:** Industriële kwaliteit in verschillende uitvoeringen.

Onderdelen compressoren

- Diversen**
- Malleabele fittingen & Staal**
- Ringleidingssystemen**

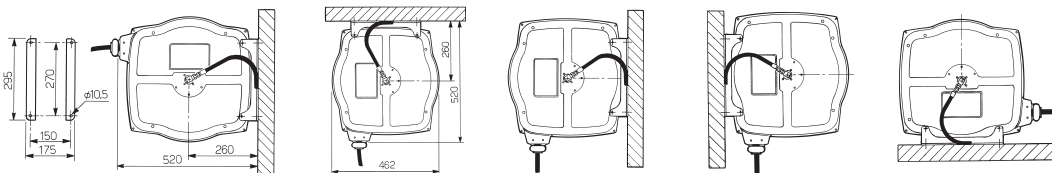

Slangen

- Water, Gas, Sanitair, Verwarming



Slang: SAE 100 R6 (14x8 = 5/16", 17x10 = 3/8", 20x13 = 1/2"). Zeer slijtvaste rubberen slang met textielinlage.



Tot 40°C



Tot 18

Zelfprollende gesloten industriële veerslanghaspel, type MC18, voor perslucht en water, blauwe haspel

VEER	~m~	kg	Uitlaat	Inlaat	Slang	€
27031710	10	20	3/8" BSP Male	3/8" BSP Fem.	14 x 8	381.80
27031715	15	20	3/8" BSP Male	3/8" BSP Fem.	14 x 8	420.75
27031720	20	20	3/8" BSP Male	3/8" BSP Fem.	14 x 8	460.75
27031810	10	20	3/8" BSP Male	3/8" BSP Fem.	17 x 10	388.30
27031815	15	20	3/8" BSP Male	3/8" BSP Fem.	17 x 10	432.60
27032110	10	20	1/2" BSP Male	1/2" BSP Male	20 x 13	452.10



Slang: soepele gewapende PU slang



Tot 40°C



Tot 20

Zelfprollende gesloten industriële veerslanghaspel, type MC20, voor perslucht en water, blauwe haspel

VEER	~m~	kg	Uitlaat	Inlaat	Slang	€
27030820PU	20	20	3/8" BSP Male	3/8" BSP Fem.	PU 12 X 8	444.50
27031020PU	20	20	3/8" BSP Male	3/8" BSP Fem.	PU 14 X 10	460.75
27031315PU	15	20	1/2" BSP Male	1/2" BSP Male	PU 18 X 13	496.45

Veerslanghaspels



FAICON 14



Slang: ID 9,5 mm (3/8" EN 857 1SC)



Tot 40°C



Tot 60

Zelfprollende gesloten industriële veerslanghaspel, type MC60, voor water en olie, blauwe haspel



27041710	VEERH-MC60-10 M. 17-9	10	20	3/8" BSP Male	3/8" BSP Fem.	ID 9,5	452.10
27041715	VEERH-MC60-15 M. 17-9	15	20	3/8" BSP Male	3/8" BSP Fem.	ID 9,5	479.10

Uitvoering met slang ID 13 is op aanvraag leverbaar met een werklengete van 10 meter.



Slang: ID 6,35 mm (1/4" EN 853 2SN)



40°C



Tot 400

Zelfprollende gesloten industriële veerslanghaspel, type MC4G, voor hogedruk vet, rode haspel



27051310	VEERH-MC4G-10 M. 16-6	10	20	1/4" BSP Male	1/4" BSP Fem.	ID 6,35	461.85
-----------------	-----------------------	----	----	---------------	---------------	---------	---------------



Slang: HOT WATER BLUE. (ID 8 = 5/16")



Water tot 150°C



Tot 400

Zelfprollende gesloten industriële veerslanghaspel, type MC4H, voor hogedruk heet water, rode haspel



27061710	VEERH-MC4H-10 M. 16-8	10	20	3/8" BSP Male	3/8" BSP Fem.	ID 8	491.00
27061715	VEERH-MC4H-15 M. 18-9.5	15	20	3/8" BSP Male	3/8" BSP Fem.	ID 8	578.60

Roestvast stalen zelfprollende gesloten professionele veerslanghaspels type MCX

Toepassingen: Geschikt voor perslucht en heet water. Wordt gebruikt in o.a. de chemie, farmaceutische industrie, grootkeukens, laboratoria, levensmiddelen industrie, marine- en scheepsbouw, offshore, reinigingstechniek, slachterijen, tampon drukkerijen, zwembaden enz.

Levering: Koppelingen worden geleverd met beschermmof. Standaard levering met vaste RVS bevestiging, geschikt voor wand- en plafondmontage. Voor 180° draaibare RVS beugels zie Faicom accessoires, artikel MCXSG10.

Functies: Automatische terugloop, met blokkeer-standen op de gewenste slanglengtes. De professionele RVS draaibare inlaatkoppeling zorgt voor perfecte dichting en soepel draaiwerk. Deze draaikoppeling (swivel) (ook los verkrijgbaar) is voorzien van speciale dichtingen, aangepast aan de werkdruk en het medium.

Kwaliteit: Zware industriële kwaliteit met 4 rolgeleiders. Geproduceerd in de EU, 2 jaar garantie.

Materiaal: Haspel: RVS AISI-304. Plaatmateriaal, bevestigingstechniek en draadelen van RVS en/of chemisch vernikkeld.
Slang: HOT WATER BLUE (ID 8 = 1/2" en ID 8 = 5/16")

Afmetingen: Zie de technische tekeningen op de vorige pagina.



RVS-zelfprollende gesloten industriële veerslanghaspel, type MCX



MCX101310K	RVS-VEERH-MCX-10 M. 21-13	10	80	10	20	1/2" BSP Male	1/2" BSP Male	ID 13	838.15
MCX4H5110	RVS-VEERH-MCX-10 M. 16-8	400	150	10	20	3/8" BSP Male	3/8" BSP Fem.	ID 8	889.05
MCX4H5115	RVS-VEERH-MCX-15 M. 18-9	400	150	15	20	3/8" BSP Male	3/8" BSP Fem.	ID 8	962.55

Veerslanghaspels



FAICOM 14

Slang: ID 6,35 mm (1/4" EN 853 2SN)

Tot 40°C

Tot 400

Zelfoprollende open industriële veerslanghaspel, type V4G, voor hogedruk vet



27091315VS	15	20	1/4" Male	1/4" Female	ID 6,35	532.15
-------------------	----	----	-----------	-------------	---------	---------------

HOT WATER BLUE
(ID 8 = 5/16" en ID 9,5 = 3/8")

Water Tot 150°C

Tot 400

Zelfoprollende open industriële veerslanghaspel, type V4H, voor hogedruk heet water



27101710VS	10	20	3/8" Male	3/8" Female	ID 8	491.00
27101715VS	15	20	3/8" Male	3/8" Female	ID 9,5	607.85

RVS zelfoprollende open industriële veerslanghaspel type VX

- Toepassingen:** Geschikt voor perslucht en heet water. Wordt gebruikt in o.a. de chemie, farmaceutische industrie, grootkeukens, laboratoria, levensmiddelen industrie, marine- en scheepsbouw, offshore, reinigingstechniek, slachterijen, tampondrukkerijen, zwembaden enz.
- Levering:** Koppelingen met beschermf. Standaard levering met vaste RVS bevestiging. Geschikt voor wand- en plafondmontage. Voor 140° draaibare RVS beugel (AXSG15) zie Faicom accessoires.
- Functies:** Automatische terugloop, met blokkeer-standen op de gewenste slanglengtes. De professionele RVS draaibare inlaatkoppeling zorgt voor perfecte dichting en soepel draaiwerk. Deze draai-koppeling (swivel) is voorzien van speciale dichtingen, aangepast aan de werkdruk en het medium. RVS swivels zijn ook los verkrijgbaar. In 3 verschillende standen fixeerbare slanggeleider met 2 rollen.
- Kwaliteit:** Zware industriële FOOD kwaliteit. Geproduceerd en getest in de EU, 2 jaar garantie.
- Materiaal:** Haspel: RVS AISI-304. Plaatmateriaal, bevestigingstechniek en draadelen van RVS en/of chemisch vernikkeld.
Slang: Zeer slijtvlaste industriële kwaliteit HOT WATER BLUE slang.
- Afmetingen:** Zie de technische tekeningen op de vorige pagina.



RVS-zelfoprollende open industriële veerslanghaspel, type VX, voor hogedruk heet water, 15 meter



VX101315K	15m	10	80	20	1/2" BSP Male	1/2" BSP Male	ID 13	811.10
VX4H5115	15m	400	150	20	3/8" BSP Male	3/8" BSP Fem.	ID 8	906.30
VX4H3815	15m	400	150	20	3/8" BSP Male	3/8" BSP Fem	ID 9,5	896.60

Hydrauliek
Snelkoppelingen
Afsluiters
Roestvast staal
Fittingen
Luchtconditionering
Gereedschap
Vacuumtechniek
Pneumatiek
Onderdelen compressoren
Diversen
Malleabele fittingen & Staal
Ringleidingssystemen
Slangen
Water, Gas, Sanitair, Verwarming

14 Veerslanghaspels



Hydrauliek **Zelfoprollende open veerslanghaspel type VL (breed model)**

- Snelkoppelingen** Toepassingen: Perslucht, water (heet en koud), olie e.d.
Levering: Standaard met vaste bevestiging. Voor beugelset 140° draaibaar (27071099L), zie Faicom accessoires.
- Afsluiters** Functies: Drie verschillende standen. Fixeerbare slanggeleider met 2 rollen.
- Roestvast staal** Kwaliteit: Zware industriële kwaliteit. Geproduceerd en getest in de EU, 2 jaar garantie.
Materiaal: Haspel: Plaatstaal is in en uitwendig bad verzinkt en epoxy gecoat.
UV bestendig.
- Fittingen** Onderdelen die in contact komen met het medium zijn extra tegen corrosie behandeld.
Slang: Zeer slijtvaste industriële kwaliteit in verschillende uitvoeringen.

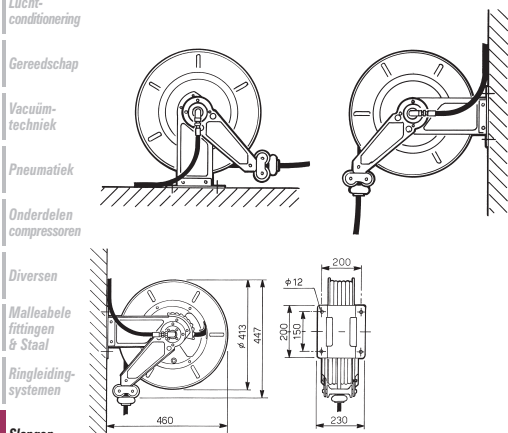

Water, Gas, Sanitair, Verwarming
Slang: SAE 100 R6 (14x8 = 5/16", 17x10 = 3/8").
Zeer slijtvaste rubberen slang met textielinlage.

Perslucht en water tot 40°C

Tot 18

Zelfoprollende open industriële veerslanghaspel, type VL18, voor perslucht & water

VEER			Uitlaat	Inlaat	Slang	€
27071725VL	25	25	3/8" BSP Male	3/8" BSP Fem.	14 x 8	526.70
27071825VL	25	25	3/8" BSP Male	3/8" BSP Fem.	17 x 10	571.05

Slang: PU Perslucht tot 20

Zelfoprollende open industriële veerslanghaspel, type VL20, voor perslucht

VEER			Uitlaat	Inlaat	Slang	€
27071725PVL	25	25	1/2" BSP Male	1/2" BSP Male	PU 18 x 13	637.05

Slang: ID 13 mm (1/2" LEANLINE) Water en olie tot 40°C Perslucht tot 60

Zelfoprollende open industriële veerslanghaspel, type VL60, voor olie & water

VEER			Uitlaat	Inlaat	Slang	€
27081720VL	20	25	1/2" BSP Male	1/2" BSP Male	ID 13	700.80

Slang: ID 9,5 (3/8" HOT WATER 400 BLUE) Water tot 150°C Tot 400

Zelfoprollende open industriële veerslanghaspel, type VL4H, voor hogedruk heet water - rode uitvoering

VEER			Uitlaat	Inlaat	Slang	€
27101720VL	20	25	3/8" Male	3/8" Fem.	ID 9,5	875.65

RVS AISI-304 zelfoprollende BREDE industriële veerslanghaspel type VLX

- Toepassingen:** Geschikt voor perslucht en heet water. Wordt gebruikt in o.a. de chemie, farmaceutische industrie, grootkeukens, laboratoria, levensmiddelen industrie, marine- en scheepsbouw, offshore, reinigingstechniek, slachterijen, tampondrukkerijen, zwembaden enz.
- Levering:** Koppelingen met beschermmof. Standaard levering met vaste RVS bevestiging. Geschikt voor wand- en plafondmontage. Voor 140° draaibare RVS beugel (AXSG20) zie Faicom accessoires.
- Functies:** Automatische terugloop, met blokkeer-standen op de gewenste slanglengtes. De professionele RVS draaibare inlaatkoppeling zorgt voor perfecte dichting en soepel draaiwerk. Deze draai-koppeling (swivel) is voorzien van speciale dichtingen, aangepast aan de werkdruk en het medium. RVS swivels zijn los verkrijgbaar. Met een in 3 verschillende standen fixeerbare slanggeleider met 2 rollen.
- Kwaliteit:** Industriële FOOD kwaliteit. Geproduceerd en getest in de EU, 2 jaar garantie.
- Materiaal:** Haspel: RVS AISI-304 Plaatmateriaal, bevestigingstechniek en draaidelen van RVS en/of chemisch vernikkeld.
- Slang:** Zeer slijtvaste industriële kwaliteit heet-water slang.
- Afmetingen:** Zie de technische tekeningen op de vorige pagina.



Hydrauliek
Snelkoppelingen
Afsluiters
Roestvast staal
Fittingen
Luchtconditionering
Gereedschap
Vacuümtechniek
Pneumatiek
Onderdelen compressoren
Diversen
Malleabele fittingen & Staal
Ringleidingssystemen
Slangen
Water, Gas, Sanitair, Verwarming



Slang: synthetisch rubber

RVS-zelfoprollende open industriële veerslanghaspel, type VLX (large)

VEER	bar	°C	m	kg	Uitlaat	Inlaat	Slang	€
VLX101320K	10	80	20	20	1/2" Male	1/2" Male	ID 13	1020.95
VLX4H3820	400	150	20	20	3/8" Male	3/8" Fem.	ID 9,5	1155.05
VLX4H5120	400	150	20	20	3/8" Male	3/8" Fem.	ID 8	1143.20

14 Veerslanghaspels



Hydrauliek **Automatische BIG open veerslanghaspels van roestvast staal type BGX**

- Snelkoppelingen** Toepassingen: Geschikt voor perslucht en heet water. Wordt gebruikt in o.a. de chemie, farmaceutische industrie, grootkeukens, laboratoria, levensmiddelen industrie, marine- en scheepsbouw, offshore, reinigingstechniek, slachterijen, tampondrukkerijen, zwembaden enz.
- Afsluiters**
- Roestvast staal** Levering: Standaard met vaste RVS bevestiging. Voor 140° draaibare RVS bevestigisjet (BGXSG30) zie Faicom accessoires.
- Fittingen** Functies: In 3 verschillende standen fixeerbaar. Slanggeleider met 4 rolgeleiders. De haspel draait op kogellagers, waardoor wrijving tot een minimum wordt beperkt.
- Luchtconditionering** Kwaliteit: Zware industriële automatische veerslanghaspel. Geproduceerd en getest in de EU, 2 jaar garantie.
- Gereedschap** Materiaal: Haspel: RVS AISI-304 Plaatmateriaal, bevestigingstechniek en draaidelen van RVS en/of chemisch vernikkeld.
- Vacuumtechniek** Slang: Zeer slijtvaste industriële kwaliteit heet-water slang. Maximale flow.
- Pneumatiek** Afmetingen: Zie technische tekeningen op de vorige pagina.

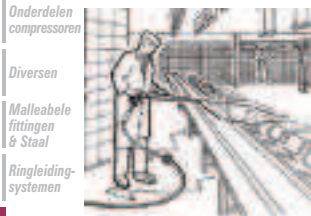

Slangen

Water, Gas, Sanitair, Verwarming

Slang: SAE 100 R6

Water tot 80°C

Tot 10

RVS BIG zelfoprollende open industriële veerslanghaspel, type BGX, voor water

BGX101325K	25	45	1/2" BSP Male	1/2" BSP Female	ID 13	1670.90
BGX101920K	20	45	3/4" BSP Female	3/4" BSP Female	ID 19	1728.25
BGX102515K	15	45	1" BSP Female	1" BSP Female	ID 25	1748.80

Slang: synthetisch rubber

Water tot 150°C

Tot 300

RVS BIG zelfoprollende open industriële veerslanghaspel, type BGX, voor hogedruk heet water - rode uitvoering

BGX3H1225	25	45	1/2" BSP Female	1/2" BSP Fem.	ID 13	2022.40

Uitvoering voor 400 bar is op aanvraag leverbaar.

Veerslanghaspels



FAICOM 14

Automatische open veerslanghaspels type BG

- Toepassingen:** Perslucht, lage- en hogedruk water (heet en koud) en olie.
- Levering:** Standaard met vaste bevestiging.
- Functies:** Geschikt voor vaste en zwenkbare opstelling. Voor 140° draaibare bevestigingsset (BGSG30) zie Faicom accessoires. Met een in 3 verschillende standen fixeerbare slanggeleider met 4 rollen. De haspel draait op kogellagers, waardoor wrijving tot een minimum wordt beperkt.
- Kwaliteit:** Zware industriële automatische veerslanghaspel. Geproduceerd en getest in de EU, 2 jaar garantie.
- Materiaal:** Haspel: Plaatstaal is in en uitwendig bad verzinkt en epoxy gecoat. UV bestendig.
Onderdelen die in contact komen met het medium zijn extra tegen corrosie behandeld.
Slang: Max. flow, industriële kwaliteit, in verschillende uitvoeringen.



- Hydrauliek
- Snelkoppelingen
- Afsluiters
- Roestvast staal
- Fittingen
- Luchtconditionering
- Gereedschap
- Vacuümtechniek
- Pneumatiek
- Onderdelen compressoren
- Diversen
- Malleabele fittingen & Staal
- Ringleidingssystemen
- Slangen**
- Water, Gas, Sanitair, Verwarming

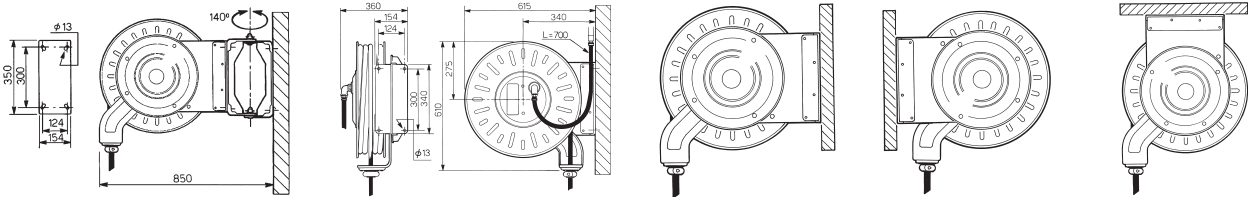

Slang: SAE 100 R6 (20x13 = 1/2", 27x19 = 3/4", 34x25 = 1")
Zeer slijtvaste rubberen slang met textielinlage.

Perslucht en water tot 40°C

Tot 18

Zelfoprollende open industriële veerslanghaspel, type BG18, voor perslucht & water

				Uitlaat	Inlaat	Slang	€
BG181325	25	45	45	1/2" BSP Male	1/2" BSP Female	20 x 13	1356.20
BG181330	30	45	45	1/2" BSP Male	1/2" BSP Female	20 x 13	1414.60
BG181920	20	45	45	3/4" BSP Female	3/4" BSP Female	27 x 19	1420.00
BG182515	15	45	45	1" BSP Female	1" BSP Female	34 x 25	1462.20

Slang: LEANLINE

Water en olie tot 40°C

Tot 60

Zelfoprollende open industriële veerslanghaspel, type BG60, voor olie & water

				Uitlaat	Inlaat	Slang	€
BG601225	25	45	45	1/2" BSP Female	1/2" BSP Female	ID 13	1412.45
BG603420	20	45	45	3/4" BSP Female	3/4" BSP Female	ID 19	1513.05
BG600115	15	45	45	1" BSP Female	1" BSP Female	ID 25	1563.85

Slang: synthetisch rubber

Water tot 150°C

Tot 300

Zelfoprollende open industriële veerslanghaspel, type BG3H, voor hogedruk heet water

				Uitlaat	Inlaat	Slang	€
BG3H1225	25	45	45	1/2" BSP Female	1/2" BSP Female	ID 13	1662.30

30 meter en uitvoering voor 400 bar zijn op aanvraag leverbaar.

14 Veerslanghaspels

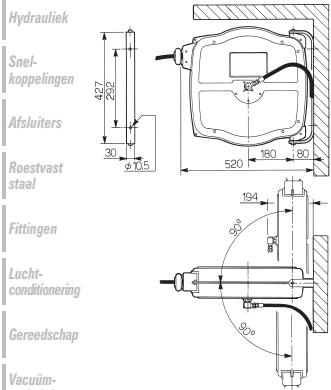

26061099L & MCXSG10

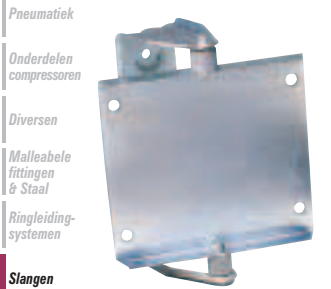

26071099S & AXSG15

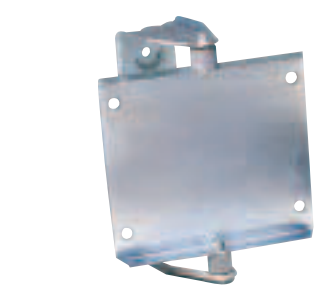
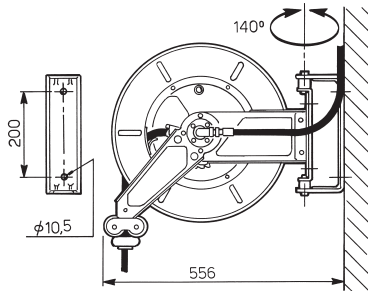

27071099L & ALXSG20

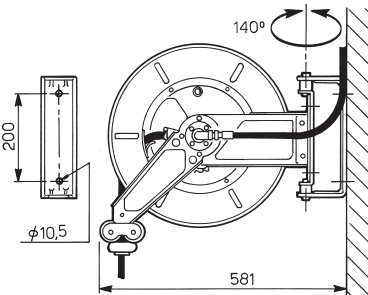

Zwenkbare bevestigingssets voor industriële veerslanghaspels

Code	Specificatie	Prijs (€)
26061099L	180° TBV. Type MC	22.40
MCXSG10	180° TBV. Type MCX (RVS)	55.30
26071099S	180° TBV. Type V	29.55
AXSG15	180° TBV. Type VX (RVS)	68.35
27071099L	180° TBV. Type VL	33.10
ALXSG20	180° TBV. Type VLX (RVS)	54.55



Vaste muurplaat

Code	Specificatie	Prijs (€)
MCCS10	Muurpl MC V. Vaste bev. Beugel MCXSG10	22.40



Beschermkap voor zijkant haspel type V, VL, VX & VLX

Code	Specificatie	Prijs (€)
VCAR	Beschermkap haspels v-	29.75



Losse slangstoppers voor industriële veerslanghaspels

Code	OD	Slang	Prijs (€)
342	11mm	11mm	8.25
127	12mm	12mm	8.25
0022A	14mm (1/4")	14mm	13.10
0022B	17mm (3/8")	17mm	13.10
0022C	20mm (1/2")	20mm	13.10
0022E	23mm (5/8")	23mm	15.60
0022F	27mm (3/4")	27mm	15.60
0022G	33mm (1")	33mm	15.60

Veerslanghaspels



FAICOM 14



90° swivels, (draaibare koppelingen) voor industriële haspels

VEER	Type	BSPP	€
0065A	65A	3/8" Female	18.25
0065D	65D	1/2" Male	21.85
0066A	66A	1/4" Female	35.05
0066A1	66A1	3/8" Female	35.05
0066B	66B	3/8" Female	35.05



90° swivels, (draaibare koppelingen) voor roestvaststalen industriële haspels

VEER	Type	BSPP	€
0065CX	65CX	1/2" Male	54.50
0066BX	66BX	3/8" Female	54.50

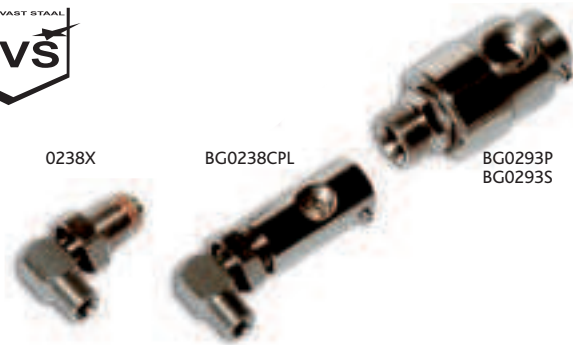

90° swivels, (draaibare koppelingen) voor industriële haspels, type BG EN BGX - type X = RVS

VEER	Type	BSPP	€
0065CX	65CX	1/2" Male	54.50
0066BX	66BX	3/8" Female	54.50

Hydrauliek
Snelkoppelingen
Afsluiters
Roestvast staal
Fittingen
Luchtconditionering
Gereedschap
Vacuümtechniek
Pneumatiek
Onderdelen compressoren
Diversen
Malleabele fittingen & Staal
Ringleidingssystemen
Slangen
Water, Gas, Sanitair, Verwarming



Aansluit slang compleet met koppeling voor Faicom industriële veerslanghaspels 0,5 meter lengte

VEER		bar	°C	To Suit	Uitlaat	Inlaat	Slang	€
TC08005	Aslang 14x8 (5/16"SAE100R6)	18	40	MC,A, AL, V, VL	3/8" BSP Fem.	3/8" BSP Male	14 x 8	14.70
TC10005	Aslang 17x10 (3/8"SAE100R6)	18	40	MC,A, AL, V, VL	3/8" BSP Fem.	3/8" BSP Male	17 x 10	14.70
TC13005	Aslang 20x13 (1/2"SAE100R6)	18	40	MC,A, AL, V, VL	1/2" BSP Fem.	1/2" BSP Fem.	20 x 13	22.95
TC38005	Aslang ID9,5 (3/8"EN857-1SC)	60	40	MC,A, AL, V, VL	3/8" BSP Male	3/8" BSP Fem.	ID 9,5	19.70
TC12005	Aslang ID13 (1/2"Leanline)	60	40	MC,A, AL, V, VL	1/2" BSP Fem.	1/2" BSP Fem.	ID 13 (1/2")	19.90
TC14005	Aslang ID 6,35 (1/4"EN853-2SN)	400	40	MCX,A, AL, V, VL	1/4" BSP Male	1/4" BSP Fem.	ID 6,35	15.15
TC13005K	ASLANG ID 13 (Thermoplast)	12	80	MCX,AX, ALX, VX, VLX	1/2" BSP Fem.	1/2" BSP Fem.	ID 13 (1/2")	18.75
TC38005H	Slang ID 9,5/MCX-AX-ALX-VX-VLX (400 Blue)	400	150	MCX,AX, ALX, VX, VLX	3/8" BSP Male	3/8" BSP Fem.	ID 9,5 (3/8")	18.75

14 Veerslanghaspels



ZECA

Hydrauliek **Voor perslucht en koud water**

- Snelkoppelingen** Industriële haspels met een moderne vormgeving
- Afsluiters** Gladde versterkte soepele polyurethaan slang met grote doorlaat
Huis uit slagvast ABS kunststof met twee geleiderollen
Automatische blokkering op elke 50 cm.
- Roestvast staal** Compleet geleverd met een metalen zwenkbeugel
Plafond montage mogelijk met ombouwkits 949/805-7000

Fittingen

Luchtconditionering  15

Gereedschap



Vacuumtechniek

Pneumatiek

Onderdelen compressoren

Diversen

Veerslanghaspels voor perslucht en koud water - kunststof - zilvergrijs met zwarte afsluitdeksels

Malleabele fittingen & Staal	ZVEE		BSPT	ID mm			H mm	B mm	€
Ringleidingssystemen	ZH805/8/S	VEERHASPEL 16m - 8mm (5/16") inw.	1/4"	8	15 + 1	Grijs	380	205	220.65
	ZH805/10/S	VEERHASPEL 16m - 10mm (3/8") inw.	3/8"	10	15 + 1	Grijs	380	205	232.50

Slangen

Water, Gas, Sanitair, Verwarming



Veerslanghaspels

ZECA 14

Voor 230 en 400 volt

Industriële kabel haspels met een moderne vormgeving
 Slijtvaste PVC (Ho5VV-F) kabel.
 Voorzien van dubbele aarding.
 Huis van slagvast kunststof en met twee geleiderollen
 Met automatische blokkering op iedere 50 cm.
 Beschermklasse: IP42.
 Wordt geleverd compleet met zwenkbeugel voor wandmontage
 Alle gele haspels t/m 3-aderig hebben een thermische beveiliging.



- Hydrauliek
- Snelkoppelingen
- Afsluiters
- Roestvast staal
- Fittingen
- Luchtconditionering
- Gereedschap
- Vacuümtechniek
- Pneumatiek
- Onderdelen compressoren
- Diversen
- Malleabele fittingen & Staal
- Ringleidingssystemen

Veerkabelhaspels voor elektriciteit - 12, 24 en 230 volt - kunststof - geel of grijs met zwarte afsluitdeksels

ZVEE	Aderig	Dia Ader			KW OP	KW AF	€
ZH4315	3	1,5	Geel	14+1	1,2 Kw	1,8 Kw	186.05
ZH4325	3	2,5	Geel	9+1	1,9 Kw	2,5 Kw	194.65
ZH7315	3	1,5	Grijs	25+2	1,1 Kw	1,8 Kw	321.25
ZH7325	3	2,5	Grijs	20+2	2,0 Kw	3,0 Kw	334.85

Zeca veerkabelhaspels voor elektriciteit - 400 volt - kunststof - geel of grijs met zwarte afsluitdeksels

ZVEE	Aderig	Dia Ader			KW OP	KW AF	€
ZH4415	4	1,5	Geel	10+1	1,4 Kw	1,9 Kw	229.30
ZH4515	5	1,5	Geel	8+1	1,4 Kw	1,9 Kw	248.75
ZH7415	4	1,5	Grijs	25+2	1,1 Kw	1,8 Kw	349.35
ZH7425	4	2,5	Grijs	18+2	2,0 Kw	3,0 Kw	531.60
ZH7525	5	2,5	Grijs	15+2	2,0 Kw	3,0 Kw	394.70

De haspels, serie 7000 (grijze uitvoering) worden standaard geleverd met de blokkering in stand "uit"
 Plafond montage mogelijk met ombouwkit 949/4000 (serie 4000) en 949/805-7000 (serie 7000)

Slangen
 Water, Gas, Sanitair, Verwarming

14 Veerslanghaspels



Hydrauliek **Met korflooplamp**

- Snelkoppelingen** Geschikt voor 12, 24 of 230 volt.
Slijtvaste PVC (H05VV-F) kabel
Huis van slagvast kunststof
- Afsluiters** Met twee geleiderollen
Met automatische blokkering op iedere 50 cm.
- Roestvast staal** Beschermklasse Haspel: IP42 Lamp: IP20
Lamp (exclusief): maximaal 60 watt
Voedingskabel: lengte 1 meter
- Fittingen** Wordt geleverd compleet met zwenkbeugel voor wandmontage,
blokkeerinrichting naar keuze uit te schakelen.
- Luchtconditionering** Plafond montage mogelijk met ombouwkit 949/5000.



- Gereedschap
- Vacuumtechniek
- Pneumatiek
- Onderdelen compressoren
- Diversen
- Malleabele fittingen & Staal
- Ringleidingssystemen
- Slangen**
- Water, Gas, Sanitair, Verwarming

Zeca veerhaspels met korflooplamp
- kunststof - zilvergrijs met zwarte afsluitdeksels

ZH5507/t306	Gloeilamp	2 x 1	14 +1,5	Grijs	163.30

Met PL looplamp

- Aansluiting 230 volt
Slijtvaste rubber (H05RN-F) kabel
Huis van slagvast kunststof en met twee geleiderollen
- Met automatische blokkering op iedere 50 cm.
Beschermklasse Haspel: IP42 Lamp: IP55
Lamp (inclusief): PL lamp 4-pins 2G7 - 11 Watt
Voedingskabel: lengte 1 meter
- Wordt geleverd compleet met zwenkbeugel voor wandmontage,
blokkeerinrichting naar keuze uit te schakelen.
- Plafond montage mogelijk met ombouwkit 949/5000.



Veerhaspels met PL lamp -11 watt
- kunststof - grijs met zwarte afsluitdeksels

ZH5507/328/230	Pllamp	2 x 1	14 +1,5	Grijs	249.85

Met LED looplamp

- Aansluiting 230 volt
Slijtvaste rubber (H05RN-F) kabel
Huis van slagvast kunststof en met twee geleiderollen
- Met automatische blokkering op iedere 50 cm.
Beschermklasse Haspel: IP52 Lamp: IP55
Lamp (inclusief): 30 ultra witte leds
Voedingskabel: lengte 1 meter
- Wordt geleverd compleet met zwenkbeugel voor wandmontage,
blokkeerinrichting naar keuze uit te schakelen.
- Plafond montage mogelijk met ombouwkit 949/5000.



Veerhaspels met 30 leds ultrawit
- kunststof- geel met zwarte afsluitdeksels

ZH5907/329/230	Ledlamp	2x1	14 +1,5	Geel	237.95

Bestendigheidstabel

De chemische stoffen zijn bij de opgegeven temperaturen zorgvuldig onderzocht en daarna in de bestendigheidstabel geplaatst. Als er geen vermelding in de kolom staat zijn er geen testgegevens beschikbaar m.b.t. het desbetreffende materiaal.

Deze bestendigheidlijst dient als richtlijn. Wij zijn niet aansprakelijk voor schade die eventueel zou kunnen voortvloeien uit deze gegevens. Bij onduidelijkheid of vragen neemt u s.v.p. contact met ons op.

Tekstverklaring: bestendig = b beperkt bestendig = bb niet bestendig = n

Medium	Concentratie %	°C	PVC	PA	PU	PE	PPC	Vinnylan	
Accuzuur	–	50	bb	bb	n	b	b	bb	Hydrauliek
Accuzuur	–	20	bb	bb	n	b	b	b	Snelkoppelingen
Aceton	100%	20	n	b	b	n	b	n	Afsluiters
Acrylnitriet	100%	20	–	b	–	b	–	–	Roestvast staal
Afvalzouten	–	20	b	–	–	–	–	–	Fittingen
Afwasmiddel	–	20	b	–	–	–	b	–	Luchtconditionering
Alcohol	96%	20	bb	–	–	–	b	–	Gereedschap
Aluin	verdund	20	bb	–	–	–	b	b	
Aluminiumchloride	verdund	23	–	–	–	b	b	b	
Aluminiumhydroxide	geconcentreerd	23	–	–	–	b	b	–	Vacuümtechniek
Aluminiumsulfaat	10%	20	–	b	b	b	b	–	
Ammoniak (gas)	100%	20	b	–	–	b	–	b	Pneumatiek
Ammoniak (in water)	geconcentreerd	–	–	–	–	–	–	b	
Ammoniak (in water)	10%	20	b	–	–	b	b	b	Onderdelen compressoren
Ammoniumacetaat (in water)	elke	20	b	–	–	–	b	b	
Ammoniumchloride	10%	20	–	b	bb	b	b	b	Diversen
Aniline	100%	23	n	bb	n	b	b	n	
Antimoonchloride	verzadigd	23	–	–	–	b	b	–	
Antivries	–	20	b	–	–	–	b	b	Malleabele fittingen & Staal
Arseenzuur	100%	23	–	–	–	b	b	–	Ringleidingssystemen
Asfalt	–	20	bb	b	b	n	–	bb	
Azijnzuur	98%	20	n	n	n	b	b	n	
Azijnzuur	10%	20	–	b	b	b	b	b	
Bakkersgist	–	20	b	–	–	–	–	–	Slangen
Bariumcarbonaat	verzadigd	23	–	–	–	b	b	–	
Bariumchloride	verzadigd	23	–	–	–	b	b	b	Water, Gas, Sanitair, Verwarming
Bariumhydroxide	verzadigd	23	–	–	–	b	b	–	
Bariumsulfaat	verzadigd	23	–	–	–	b	b	–	
Benzeen	100%	23	n	b	b	n	bb	n	
Benzeenzuur	verzadigd	23	–	–	–	b	bb	–	
Benzine	100%	20	–	b	b	n	bb	b	
Bier	–	20	b	–	–	b	b	–	
Blauwzuur	–	20	b	–	–	–	b	–	
Bleekwater (0,1 % Act. Chloor)	–	20	–	n	n	bb	bb	–	
Boenwas	–	20	bb	–	–	–	–	bb	
Boorzuur	10%	20	–	b	b	b	b	b	
Borax	verzadigd	23	–	–	–	b	–	n	
Boter	–	20	n	bb	bb	b	b	–	
Brandwijn	–	–	–	b	b	b	b	–	
Broom (vloeibaar)	100%	20	n	–	–	–	n	n	
Broomzuur	50%	23	–	–	–	b	bb	n	
Butaan (vloeibaar)	100%	20	n	b	b	n	b	n	
Calciumcarbonaat	verzadigd	23	–	bb	bb	b	b	–	
Calciumchloride	verzadigd	23	–	–	n	n	b	b	
Calciumhydroxide	verzadigd	23	–	–	–	b	b	–	
Calciumnitraat	verzadigd	23	–	–	–	b	b	b	
Calciumsulfaat	verzadigd	23	–	–	–	b	b	–	
Chloorgas	100%	20	–	n	bb	n	n	n	
Chloorwater	–	20	–	n	n	n	bb	n	
Chloroform	100%	20	–	n	n	n	bb	n	
Chroomzuur	1%	20	–	bb	n	b	b	–	
Chroomzwavelzuur	–	20	n	–	–	bb	n	n	
Citroensap	–	20	b	–	–	b	b	b	
Citroenzuur	10%	20	–	b	b	b	b	b	
Citroenzuur	verzadigd	23	b	–	–	b	b	–	
Cyaankali	waterig	20	b	b	b	–	b	–	
Dextrose	verzadigd	23	–	–	–	b	b	–	
Dieselolie	100%	20	bb	b	b	n	b	n	
Eiwitoplossing	–	20	b	–	–	–	–	–	
Ethanol	96%	20	–	b	b	b	b	bb	
Ethanol	10%	20	b	–	–	–	b	b	
Ether	–	20	n	–	–	–	n	–	
Etherische olie	–	20	bb	–	–	–	–	–	

14 Bestendigheidstabel

	Medium	Concentratie %	°C	PVC	PA	PU	PE	PPC	Vinnylan
Hydrauliek	Ethylacetaat	100%	20	n	-	-	-	b	n
	Fixeer	100%	20	b	-	-	-	b	b
	Fluorwaterstof	40%	20	-	n	n	n	b	-
Snelkoppelingen	Foazelolie	-	20	bb	-	-	-	-	-
	Formaldehyde	40%	23	-	-	-	b	b	bb
Afsluiters	Fosforzuur	10%	20	b	b	bb	b	b	b
	Freon 12dichloor	-	-	-	-	-	-	-	-
Roestvast staal	difluormethaan	-	20	-	b	bb	n	n	-
	Fructose	verzadigd	23	-	-	-	b	b	-
Fittingen	Gasoline	100%	20	n	-	-	-	bb	n
	Gedestilleerd water	-	20	b	-	-	-	b	-
Luchtconditionering	Gelatine	-	20	b	-	-	-	b	-
	Gesmolten was	-	-	-	b	b	b	bb	-
Gereedschap	Gluhwijn	-	20	b	-	-	b	b	b
	Glycerine	100%	23	bb	b	b	b	b	b-bb
Vacuumtechniek	Glycerol	100%	20	bb	-	-	-	b	b-bb
	Glycol	100%	20	bb	-	-	-	b	b-bb
Pneumatiek	Glycolzuur	30%	23	-	-	-	b	b	-
	Haarshampoo	-	20	b	-	-	-	b	b
Onderdelen compressoren	Hexaan	100%	20	n	b	-	b	b	n
	Ijzerchloride	10%	20	-	b	b	b	b	-
Diversen	Ijzerdichloride	verzadigd	23	-	-	-	b	-	-
	Ijzernittraat	verzadigd	23	-	-	-	b	b	-
Malleabele fittingen & Staal	Ijzerzout	verzadigd	20	b	-	-	-	b	b
	Inkt	-	20	b	-	-	-	-	b
Ringleidingssystemen	Jodiumtinctuur	-	20	-	n	n	b	b	-
	Kaliloog	10%	20	b	b	b	b	b	b
Slangen	Kaliumbromide	verzadigd	23	-	-	-	b	b	-
	Kaliumcarbonaat	geconcentreerd	23	-	-	-	b	b	n
Water, Gas, Sanitair, Verwarming	Kaliumcarbonaat (in water)	verzadigd	20	b	-	-	-	b	b
	Kaliumchloride	verzadigd	23	-	-	-	b	b	-
Slangen	Kaliumchloride (in water)	verzadigd	20	b	-	-	-	b	b
	Kaliumhydroxide	20%	23	-	-	-	b	b	-
Water, Gas, Sanitair, Verwarming	Kaliumjodide	verzadigd	20	b	-	-	-	b	b
	Kaliumnittraat	verzadigd	23	-	-	-	b	b	-
Water, Gas, Sanitair, Verwarming	Kaliumnittraat	10%	20	-	bb	b	b	b	-
	Kaliumsulfaat	geconcentreerd	23	-	-	-	b	b	-
Water, Gas, Sanitair, Verwarming	Kaliumsulfaat (in water)	verzadigd	20	b	-	-	-	b	-
	Kaliumsulfiet	geconcentreerd	23	-	-	-	b	b	-
Water, Gas, Sanitair, Verwarming	Kaliumwaterglas	-	20	b	-	-	-	-	b
	Kalizeep	-	20	b	-	-	-	b	-
Water, Gas, Sanitair, Verwarming	Keukenzout	-	20	b	-	-	-	b	b
	Kiezelsuur	verzadigd	23	-	-	-	b	b	-
Water, Gas, Sanitair, Verwarming	Kooldioxide	-	20	b	-	-	-	b	-
	Koperchloride	verzadigd	23	-	n	n	b	b	-
Water, Gas, Sanitair, Verwarming	Kopernittraat	verzadigd	23	-	-	-	b	b	-
	Kopersulfaat	10%	20	-	b	-	b	b	-
Water, Gas, Sanitair, Verwarming	Koud water	-	-	-	b	b	b	b	b
	Kunstzijde	-	20	b	-	-	-	b	-
Water, Gas, Sanitair, Verwarming	Lanoline	-	20	bb	-	-	-	b	bb
	Latex	100%	23	-	-	-	b	b	-
Water, Gas, Sanitair, Verwarming	Lijnolie	-	20	bb	b	b	n	b	-
	Limonade	-	20	b	-	-	b	b	b
Water, Gas, Sanitair, Verwarming	Loodacetaat	verzadigd	23	-	-	-	b	b	-
	Loodzout	-	20	b	-	-	-	-	-
Water, Gas, Sanitair, Verwarming	Looistof	-	20	b	-	-	-	b	-
	Magnesiumcarbonaat	verzadigd	23	-	-	-	b	b	-
Water, Gas, Sanitair, Verwarming	Magnesiumchloride	verzadigd	23	-	-	-	b	b	-
	Magnesiumhydroxide	verzadigd	23	-	-	-	b	b	-
Water, Gas, Sanitair, Verwarming	Magnesiumnittraat	verzadigd	23	-	-	-	b	b	-
	Magnesiumsulfaat	verzadigd	23	-	-	-	b	b	-
Water, Gas, Sanitair, Verwarming	Magnesiumzout	verzadigd	20	b	-	-	-	b	b
	Mayonaise	-	20	bb	-	-	b	-	b-bb
Water, Gas, Sanitair, Verwarming	Melkzuur	10%	20	-	n	n	b	b	b
	Meststofzout	100%	20	n	-	-	b	-	-
Water, Gas, Sanitair, Verwarming	Methanol	-	20	-	b	b	b	b	n
	Methylacetaat	100%	20	-	b	b	-	b	n
Water, Gas, Sanitair, Verwarming	Methylalcohol	100%	20	n	-	-	-	b	n
	Methylalcohol (in water)	50%	20	bb	-	-	-	b	n

Bestendigheidstabel

Medium	Concentratie %	°C	PVC	PA	PU	PE	PPC	Vinnylan	
Methylbenzeen	100%	20	n	–	–	–	bb	n	Hydrauliek
Methyleenchloride	100%	23	n	n	bb	b	bb	n	Snelkoppelingen
Mierenzuur	98%	20	n	n	n	n	b	n	Afsluiters
Mierenzuur	10%	20	b	n	n	b	b	b	
Mineraalolie	100%	23	–	b	b	bb	b	n	
Mineraalolie (aromatenvrij)	–	20	bb	–	–	–	b	bb	Roestvast staal
Nagellak	–	20	n	b	–	–	–	n	
Nagellakremover	–	20	n	–	–	–	–	n	
Natriumcarbonaat	verzadigd	23	–	–	–	b	b	n	Fittingen
Natriumcarbonaat	10%	20	–	b	b	b	b	b	
Natriumcarbonaat (in water)	verzadigd	20	b	b	b	–	b	bb	
Natriumchloride	10%	20	–	bb	bb	b	b	b	Luchtconditionering
Natriumfosfaat (in water)	verzadigd	20	b	–	–	–	b	b	
Natriumhydroxide	10%	20	b	–	–	–	b	–	Gereedschap
Natriumnitraat (in water)	verzadigd	20	b	–	–	–	b	bb	
Natriumsulfaat	10%	20	–	n	n	b	b	b	Vacuümtechniek
Natriumsulfide (in water)	verzadigd	20	b	–	–	b	b	b	
Natronloog	10%	20	bb	b	b	b	b	b	
n-butylalcohol	100%	20	n	–	–	–	–	n	Pneumatiek
Nicotinezuur	100%	23	–	–	–	b	b	–	
Nikkelchloride	verzadigd	23	–	–	–	b	b	b	Onderdelen compressoren
Nikkelnitraat	geconcentreerd	23	–	–	–	b	b	–	
Nikkelsulfaat	verzadigd	23	–	–	–	b	b	–	
Nitrobenzeen	100%	20	n	–	–	–	b/bb	n	Diversen
Nitroglycerine	–	20	bb	–	–	–	b	–	
Octaan	100%	20	n	–	–	–	b	–	Malleabele fittingen & Staal
Oxaalzuur	10%	20	–	n	–	b	b	b	
Ozon	–	20	–	n	n	bb	bb	b	Ringleidingssystemen
Paraffine	100%	20	bb	–	–	–	b	bb	
Paraffineolie	100%	20	bb	–	–	–	b	bb	
Parfum	–	20	n	b	b	n	b	n	Slangen
Pectine	verzadigd	20	b	–	–	–	b	b	
Perchloorethyleen	100%	20	n	–	–	–	n	n	Water, Gas, Sanitair, Verwarming
Petroleum	100%	20	n	b	b	bb	b	n	
Propan (vloeibaar)	100%	20	n	b	b	n	b	n	
Propyleenglycol	100%	23	–	–	–	b	–	–	
Pyridine	100%	20	n	b	b	b	bb	n	
Salicylzuur	–	20	b	–	–	–	b	–	
Salpeterzuur	10%	20	bb	n	n	bb	n	b-bb	
Schoensmeer	–	20	bb	–	–	–	–	b	
Schrijfmachineolie	–	20	bb	b	b	n	–	–	
Siliciumfluorwaterstof	31.10%	23	–	–	–	b	–	–	
Sojaolie	–	20	bb	–	–	b	b	bb	
Stearinezuur	100%	20	b	–	–	b	b	b	
Stikstof	–	20	b	–	–	–	b	–	
Suikeroplossing	elke	20	b	–	–	b	b	b	
Suikersap	–	20	b	–	–	b	b	–	
Talg	–	20	–	b	b	b	b	–	
Tandenpasta	–	20	b	–	–	–	–	b	
Teer / teerolie	–	20	bb	–	–	–	b	n	
Terpentine-olie	–	20	n	–	–	–	n	n	
Testbenzine	–	20	n	b	bb	n	bb	n	
Tomatensap	–	20	b	–	–	b	–	b	
Urine	–	20	b	b	b	–	–	–	
Vaseline	–	20	bb	b	b	n	b	bb	
Vet/olie (dierlijk en plantaardig)	–	20	bb	b	b	n	b	–	
Vetalcohol	–	20	bb	–	–	–	b	–	
Vetzuur	–	20	bb	n	n	b	b	–	
Wasmiddel	hoog	20	b	–	–	b	b	b	
Water	–	20	b	b	b	b	b	b	
Waterstof	–	20	b	–	–	–	b	–	
Waterstofperoxide	0.50%	20	–	b	b	b	b	b	
Waterstofsulfide	gering	20	b	–	–	–	–	–	
Wijn	–	20	–	b	b	b	b	b	
Wijnzuur (in water)	verzadigd	20	b	–	–	–	b	b	
Xyleen	100%	20	n	b	b	n	n	n	
Zeep (vast)	–	20	b	–	–	–	–	–	
Zeewater	–	20	b	b	b	b	b	b	
Zilverzout (in water)	verzadigd	20	b	–	–	–	b	b	

14 Bestendigheidstabel

	Medium	Concentratie %	°C	PVC	PA	PU	PE	PPC	Vinnylan
Hydrauliek	Zink-2-chloride	verzadigd	20	b	–	–	b	b	b
Snef-koppelingen	Zinkchloride	10.00%	20	–	n	n	b	b	–
	Zinksulfaat	verzadigd	23	–	–	–	b	b	–
Afsluiters	Zinkzout	–	20	b	–	–	–	b	–
	Zinkzout (in water)	verzadigd	20	b	–	–	–	b	–
Roestvast staal	Zout water	elke	20	b	b	b	b	b	b
	Zoutzuur	2%	20	–	n	n	b	b	b
Fittingen	Zuurstof	–	20	b	–	–	–	b	–
	Zwavel	100%	20	b	–	–	–	b	b
Lucht-conditionering	Zwavel dioxide	gering	20	b	bb	bb	b	b	b
	Zwavelkoolstof	–	20	n	bb	b	bb	n	n
Gereedschap	Zwavelzuur	2%	20	–	n	n	b	b	b
	Zwavelzuur	96%	20	–	–	–	–	bb	n

Gereedschap

Vacuum-techniek

Werkdruk - Temperatuur verhouding

De opgegeven werkdruk in de catalogus is bij 20°C.

Pneumatiek

Bij verhoging van de temperatuur daalt de werkdruk met onderstaande temperatuurfactor.

Vermenigvuldig de opgegeven werkdruk met deze factor om de werkdruk bij de door u gewenste temperatuur te berekenen.

Onderdelen compressoren

Temperatuur (°C.)	20	30	40	50	60	70	80	90	100
Factor	1	0,95	0,82	0,74	0,62	0,51	0,44	0,40	0,3

Diversen

Malleabele fittingen & Staal

Voorbeeld: PA 6x4 toe te passen bij een temperatuur van 70° C. Wat is de toegestane werkdruk?

Volgens tabel is de berekening als volgt: Opgegeven werkdruk bij 20°C. = 27 bar x 0,51 = 13,7 bar.

Ringleiding-systemen

Deze berekening geldt voor alle slangen zonder versterking, zoals PE,PA,PA-EF,PU,PPC

Slangen

Water, Gas, Sanitair, Verwarming

PTFE

PTFE is inert to essentially all common chemicals. It is attacked by molten alkali metals, elemental fluorine, and pure oxygen at elevated temperatures. PTFE can also react, under some conditions, with alkaline earth oxides and finely divided metals such as aluminium or magnesium at elevated temperature. Absorption of solvents is noted with some chlorinated and fluorinated liquids containing no hydrogen. Solutions containing 0.1 - 2% PTFE have been obtained in perfluorokerosene in the temperature range 290-310 degrees Celcius.

Exposure to the following chemicals has been found to have no effect on PTFE:

INORGANICS

Aqua Regia
Hydrofluoric Acid
Fuming Sulfuric Acid
Chlorosulfonic Acid
Nitric Acid
Sodium Hydroxid Solution
Chlorine Gas
Hydrogen Peroxide
Acid Chlorides

ORGANICS

Alcohols
Esters
Ketones
Highly Halogenated Organics
Amines
Aromatic Solvents

OTHER

Biological Fluids
Fragrances
Food Chemicals
Printing Inks & Dyes
Industrial Oils
Oxidizers

Omreken tabel inch naar milimeter

6	152,4
5	127,0
4	101,6
3	76,2
2.1/2	63,5
2	50,8
1.1/2	38,1
1.1/4	31,8
1	25,4
3/4	19,1
1/2	12,7
3/8	8,3
1/4	6,4
1/8	3,2